



DC-F Series

Operation Manual

DC-F1111



DC-F1211

Before reading this document



This is a basic document for installation and use of an IDIS network camera. Users who are using this product for the first time, as well as users with experience using comparable products, must read this document carefully before use and heed to the warnings and precautions contained herein while using the product. Safety warnings and precautions contained in this document are intended to promote proper use of the product and thereby prevent accidents and property damage and must be followed at all times. Once you have read this document, keep it at an easily accessible location for future reference.

- The manufacturer will not be held responsible for any product damage resulting from the use of unauthorized parts and accessories or from the user's failure to comply with the instructions contained in this document.
- The information in this document is believed to be accurate as of the date of publication. The manufacturer is not responsible for any problems resulting from the use thereof. The information contained herein is subject to change without notice. Revisions or new editions to this publication may be issued to incorporate such changes.
- It is recommended that first-time users of this network camera and individuals who are not familiar with its use seek technical assistance from their retailer regarding product installation and use.
- If you need to disassemble the product for functionality expansion or repair purposes, you must contact your retailer and seek professional assistance.
- Both retailers and users should be aware that this product has been certified as being electromagnetically compatible for commercial use. If you have sold or purchased this product unintentionally, please replace with a consumer version.

Safety Symbols

Symbol	Type	Description
	Warning	An important instruction or set of important instructions that can lead to severe injury or even death if not followed.
	Caution	An instruction or set of instruction that can lead to personal injury and/or property damage if not followed.

In-Text

Symbol	Type	Description
	Caution	Important information concerning a specific function.
	Note	Useful information concerning a specific function.

Safety Precautions

WARNING

RISK OF ELECTRIC SHOCK
DO NOT OPEN

WARNING: TO REDUCE THE RISK OF ELECTRIC SHOCK,
DO NOT REMOVE COVER (OR BACK).
NO USER-SERVICEABLE PARTS INSIDE.
REFER SERVICING TO QUALIFIED SERVICE PERSONNEL.

Important Safeguards

1. Read Instructions

All the safety and operating instructions should be read before the appliance is operated.

2. Retain Instructions

The safety and operating instructions should be retained for future reference.

3. Cleaning

Remove the power from this equipment before cleaning it. Do not use liquid aerosol cleaners. Use a damp soft cloth for cleaning.

4. Attachments

Never add any attachments and/or equipment without the approval of the manufacturer as such additions may result in the risk of fire, electric shock or other personal injury.

5. Water and/or Moisture

Do not use this equipment near water or in contact with water.

6. Placing and Accessories

Do not place this equipment on an wall or ceiling that is not strong enough to sustain the camera. The equipment may fall, causing serious injury to a child or adult, and serious damage to the equipment. Wall or shelf mounting should follow the manufacturer's instructions, and should use a mounting kit approved by the manufacturer.



This equipment and cart combination should be moved with care. Quick stops, excessive force, and uneven surfaces may cause the equipment and cart combination to overturn.

Do not place this equipment in an enclosed space. Sufficient ventilation is required to prevent an increase in ambient temperature which can cause malfunction or the risk of fire.

7. Power Sources

This equipment should be operated only from the type of power source indicated on the marking label. If you are not sure of the type of power, please consult your equipment dealer or local power company.

8. Power Cord

Operator or installer must remove power and TNT connections before handling the equipment.

9. Lightning

For added protection for this equipment during a lightning storm, or when it is left unattended and unused for long periods of time, remove the power and disconnect the antenna or cable system. This will prevent damage to the equipment due to lightning and power-line surges. If thunder or lightning is common where the equipment is installed, use a surge protection device.

10. Overloading

Do not overload network port and extension cords as this can result in the risk of fire or electric shock.

11. Objects and Liquids

Never push objects of any kind through openings of this equipment as they may touch dangerous voltage points or short out parts that could result in a fire or electric shock. Never spill liquid of any kind on the equipment.

12. Servicing

Do not attempt to service this equipment yourself. Refer all servicing to qualified service personnel.

13. Damage requiring Service

Remove the power from this equipment and refer servicing to qualified service personnel under the following conditions:

- When the power-supply cord or the plug has been damaged.
- If liquid is spilled, or objects have hit the equipment.
- If the equipment has been exposed to rain or water.
- If the equipment does not operate normally by following the operating instructions, adjust only those controls that are covered by the operating instructions as an improper adjustment of other controls may result in damage and will often require extensive work by a qualified technician to restore the equipment to its normal operation.
- If the equipment has been dropped, or the cabinet damaged.
- When the equipment exhibits a distinct change in performance — this indicates a need for service.

14. Replacement Parts

When replacement parts are required, be sure the service technician has used replacement parts specified by the manufacturer or that have the same characteristics as the original part. Unauthorized substitutions may result in fire, electric shock or other hazards.

15. Safety Check

Upon completion of any service or repairs to this equipment, ask the service technician to perform safety checks to determine that the equipment is in proper operating condition.

16. Field Installation

This installation should be made by a qualified service person and should conform to all local codes.

17. Correct Batteries

Warning: Risk of explosion if battery is replaced by an incorrect type. Dispose of used batteries according to the instructions.

18. Tmra

A manufacturer's maximum recommended ambient temperature (Tmra) for the equipment must be specified so that the customer and installer may determine a suitable maximum operating environment for the equipment.

FCC Compliance Statement

THIS EQUIPMENT HAS BEEN TESTED AND FOUND TO COMPLY WITH THE LIMITS FOR A CLASS A DIGITAL DEVICE, PURSUANT TO PART 15 OF THE FCC RULES. THESE LIMITS ARE DESIGNED TO PROVIDE REASONABLE PROTECTION AGAINST HARMFUL INTERFERENCE WHEN THE EQUIPMENT IS OPERATED IN A COMMERCIAL ENVIRONMENT. THIS EQUIPMENT GENERATES, USES, AND CAN RADIATE RADIO FREQUENCY ENERGY AND IF NOT INSTALLED AND USED IN ACCORDANCE WITH THE INSTRUCTION MANUAL, MAY CAUSE HARMFUL INTERFERENCE TO RADIO COMMUNICATIONS. OPERATION OF THIS EQUIPMENT IN A RESIDENTIAL AREA IS LIKELY TO CAUSE HARMFUL INTERFERENCE, IN WHICH CASE USERS WILL BE REQUIRED TO CORRECT THE INTERFERENCE AT THEIR OWN EXPENSE.

WARNING: CHANGES OR MODIFICATIONS NOT EXPRESSLY APPROVED BY THE PARTY RESPONSIBLE FOR COMPLIANCE COULD VOID THE USER'S AUTHORITY TO OPERATE THE EQUIPMENT. THIS CLASS OF DIGITAL APPARATUS MEETS ALL REQUIREMENTS OF THE CANADIAN INTERFERENCE CAUSING EQUIPMENT REGULATIONS.

WEEE (Waste Electrical & Electronic Equipment)

Correct Disposal of This Product

(Applicable in the European Union and other European countries with separate collection systems)



This marking shown on the product or its literature, indicates that it should not be disposed with other household wastes at the end of its working life. To prevent possible harm to the environment or human health from uncontrolled waste disposal, please separate this from other types of wastes and recycle it responsibly to promote the sustainable reuse of material resources.

Household users should contact either the retailer where they purchased this product, or their local government office, for details of where and how they can take this item for environmentally safe recycling.

Business users should contact their supplier and check the terms and conditions of the purchase contract. This product should not be mixed with other commercial wastes for disposal.

Copyright

© 2013 IDIS Co., Ltd.

IDIS Co., Ltd. reserves all rights concerning this document.

Use or duplication of this document in part or whole without the prior consent of IDIS Co., Ltd. is strictly prohibited.

Contents of this document are subject to change without prior notice for reasons such as functionality enhancements.

Registered Trademarks

IDIS is a registered trademark of IDIS Co., Ltd.

Other company and product names are registered trademarks of their respective owners.

This product contains software built partially on open-source content. Codes for the corresponding open-source content are available for download. For more information, refer to the software CD (OpenSourceGuide\OpenSourceGuide.pdf) or the open source guide accompanying this document.

Table of Contents

1

Part 1 – Introduction	7
Product Features	7
Accessories	8
Overview	9
Illustrated Parts List	9
Body	9
Dome Cover	9
Cable	9
Factory Reset	10
Installation	10
Installation	10
Dimensions	11

2

Part 2 - Camera Connection	12
With DirectIP™ NVR-based Layout	12
With non DirectIP™ NVR-based Layout	13

3

Part 3 - Remote Setup	14
Camera Protocol	14
Remote Setup	14
Quick Setup	15
System	15
General	16
Date/Time	17
User/Group	17
Network	18
IP Address	18
FEN	18
Port/QoS	19
Bandwidth Control	21
Security	21
IEEE 802.1X	22

- Video22
 - Camera22
 - Streaming24
 - Webcasting26
 - MAT26
 - Privacy Masking.....27
- Event Action27
 - Email27
 - Remote Callback28
 - FTP Upload28
- Event29
 - Motion Detection29
 - Trip-Zone30
 - Tampering31
 - System Event32

4

Part 4 - IDIS Web.....33

- Web Live Mode.....34

5

Part 5 - Appendix.....36

- Setup Menu Tree (Remote Setup)36
- Troubleshooting37
- Specifications38
- Index40

Part 1 – Introduction

Product Features

DC-F1111 / DC-F1211 are IP-based network cameras that compress and transmit video over ethernet. You can use the IDIS Discovery program to change network camera settings or the IDIS Solution Suite Compact program to manage multiple network cameras. In addition, the embedded web server (IDIS Web) lets you remotely view live video using a web browser. In addition, you can use the IDIS Solution Suite Compact to manage network cameras and view/record video.



In this operation manual, the term **Remote System** refers to the computer on which the remote program (IDIS Solution Suite Compact or IDIS Web) is running.

- Supports DirectIP mode working with a DirectIP™ NVR that allows users to simply set up all required configurations without a PC
- Supports ONVIF protocol (v2.4.0)
- Multi-streaming for high-resolution and high-quality video monitoring and simultaneous recording in real-time as well as flexible configurations for those
- Supports H.264 video compression and M-JPEG still image compression algorithms
- Supports 4-stage video compression rate and multiple compression resolutions
- Video stream buffering to counter pre-/post-event buffering and network delays for improved network recording reliability
- Remote monitoring via web browser or remote software
- Automatic web casting code (HTML) generation
- Up to 10 simultaneous remote monitoring connections
- IP filtering, HTTPS, SSL, IEEE 802.1X, and configurable user authority levels for greater security
- Network bandwidth limitation and MAT features for more efficient use of network bandwidth
- Easy network access via UPnP (Universal Plug and Play) function and embedded mDNS (Multicast DNS) protocol
- Wide dynamic range compensation (Digital WDR) for improved video quality in high-contrast situations
- Slow shutter support for improved low-lighting video capture performance

- Quick and easy firmware upgrade over the network
- Redundant firmware and auto recovery features for improved system stability
- Network-based integrated management of multiple network cameras
- Multiple event detection modes: Motion Detection, Trip Zone, and Tampering
- Supports PoE (Power over Ethernet)
- Video out feature (selectable NTSC/PAL)



Remote monitoring and recording via multistreaming are available using the IDIS Solution Suite Compact program. For more information on using IDIS Solution Suite Compact, refer to its **operation manual**.



There is a limit to the number of users allowed to connect remotely via the Internet at the same time.

Accessories

Upon purchasing the product, check inside the box to make sure all the following accessories are included. External appearances and colors of the accessories may vary depending on the model.

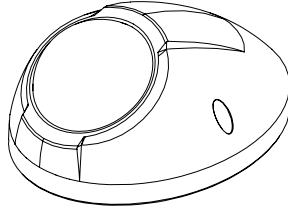

Network Camera

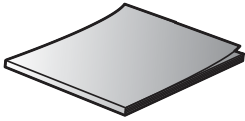

Open Source Guide

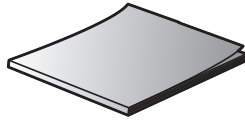

Quick Guide

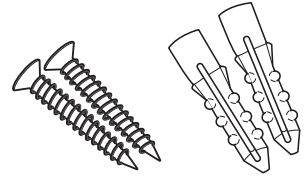

Screws

Overview

 Product color and design may vary depending on the model.

Illustrated Parts List

Body

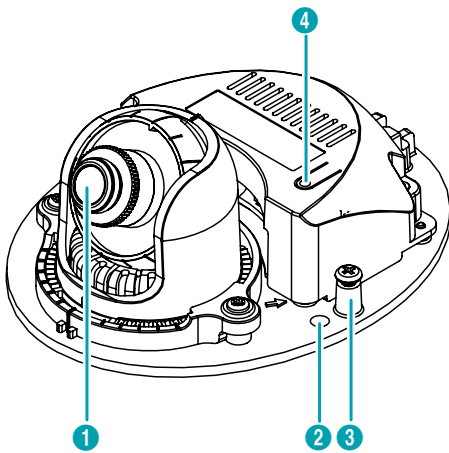

Dome Cover

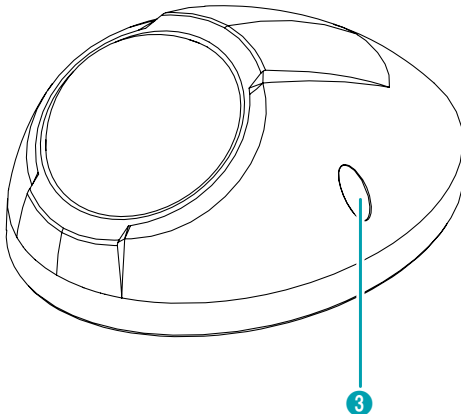

1	Lens
2	Wall/Ceiling Installation Hole
3	Dome Cover Screw Hole
4	Factory Reset Button

Cable

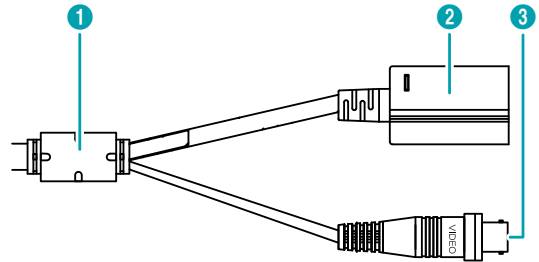

1	Ferrite Core
2	Network Port
3	Video Out

- **Lens**
Fixed lens is installed.
- **Wall/Ceiling Installation Hole**
Used to screw the camera in place on a wall or a ceiling.
- **Dome Cover Screw Hole**
Secures the dome cover to the camera.
- **Factory Reset Button**
Restores the camera's default factory settings. For more information, refer to the **Factory Reset**.
- **Cable**
 - **Ferrite Core:** It is provided for EMI (electromagnetic interference) suppression.
 - **Network Port:** Connect a network cable with an RJ-45 connector to this port. The camera is supplied with power over Ethernet cable by using a PoE switch. For more information on PoE switch use, refer to the switch manufacturer's operation manual. You can configure, manage, and upgrade this camera and monitor its images from a remote computer over the network. For more information on network connection setup, refer to the **IDIS Discovery operation manual**.
 - **Video Out (BNC):** Connect the monitor. Use these ports for previewing video and not monitoring video.

 Camera surveillance may be prohibited by laws that vary by region. Check the laws in your area before using this product for surveillance purposes.

 The network connector is not designed to be connected directly with cable or wire intended for outdoor use.

Factory Reset

Only use the factory reset button to restore the camera to its factory default settings.

 A factory reset will clear all camera settings configured by the user.

- 1 Shut off the power supply, separate the dome cover from the camera body and push the factory reset buttons.
- 2 Hold the button down and reconnect the power.
- 3 After connecting the power, wait 5 seconds and then take out hands from the button.
- 4 The device will go through the resetting process and reboot. All camera settings will be restored to their factory defaults after the reboot.
- 5 Connect the dome cover to the camera body.

It's also possible to do a factory reset by pressing and releasing the reset button while the camera is turned on or using the IDIS Discovery program from a remote location. A factory reset will reboot the system. For more information on resetting the camera remotely, refer to the [IDIS Discovery operation manual](#).

Installation

Installation of this product does not require the use of special tools.

For more information on other devices comprising the overall system, refer to their respective [installation manuals](#).

 Product color and design may vary depending on the model.

Installation

 Check the wall or ceiling to see if it needs to be reinforced. The camera may fall off if the wall or ceiling is not strong enough to support its weight.

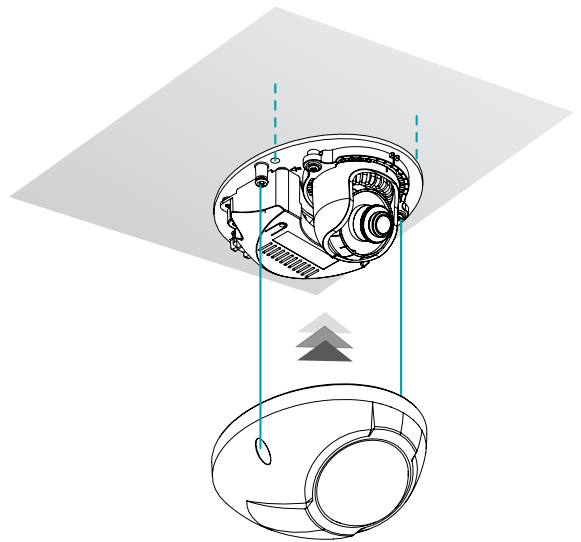

- 1 Screw the camera body to the wall or ceiling by using the mounting screws provided with the camera.
- 2 Screw the dome cover to the camera body.
- 3 Connect external devices and the network cable.

Dimensions

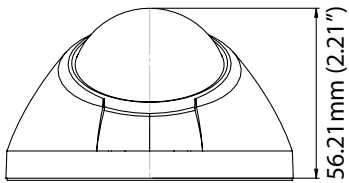
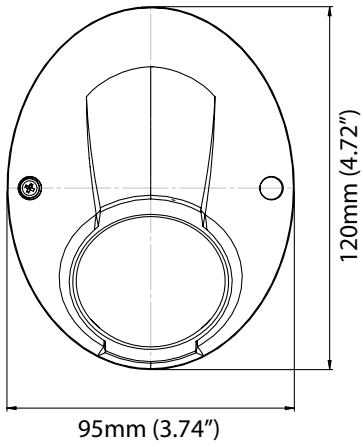

Part 2 - Camera Connection

Use the camera by connecting to DirectIP™ NVR or non DirectIP™ NVR, VMS such as IDIS Solution Suite Compact.

With DirectIP™ NVR-based Layout

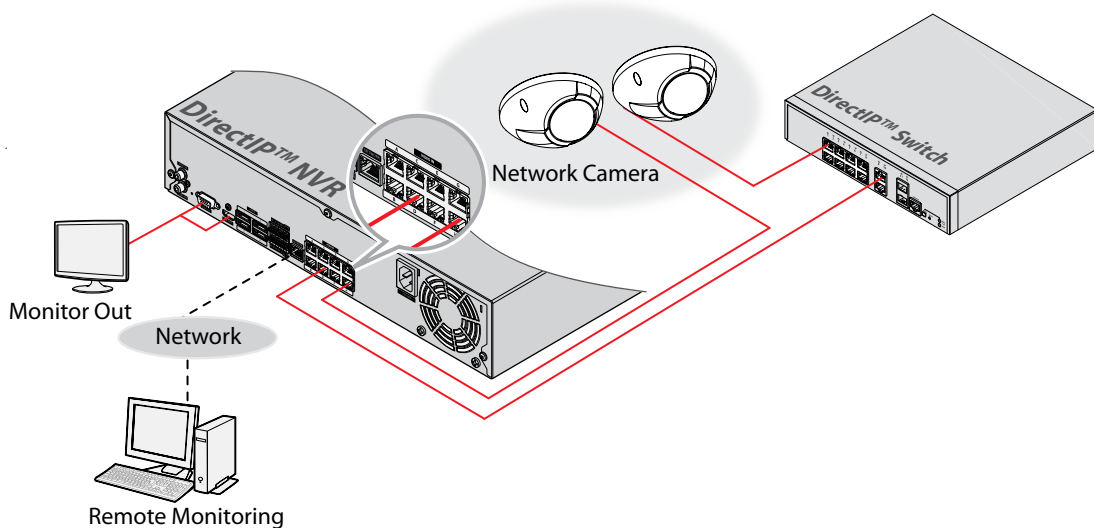

DirectIP NVR makes it easy to use cameras without extra network configurations. Each camera can be controlled via the DirectIP™ NVR setup menu, without any PC. For detailed camera settings, please see the camera setting pages of DirectIP™ NVR manual.

For users using the camera with DirectIP™ NVR connection, do not need to consider contents after page 12.

With non DirectIP™ NVR-based Layout

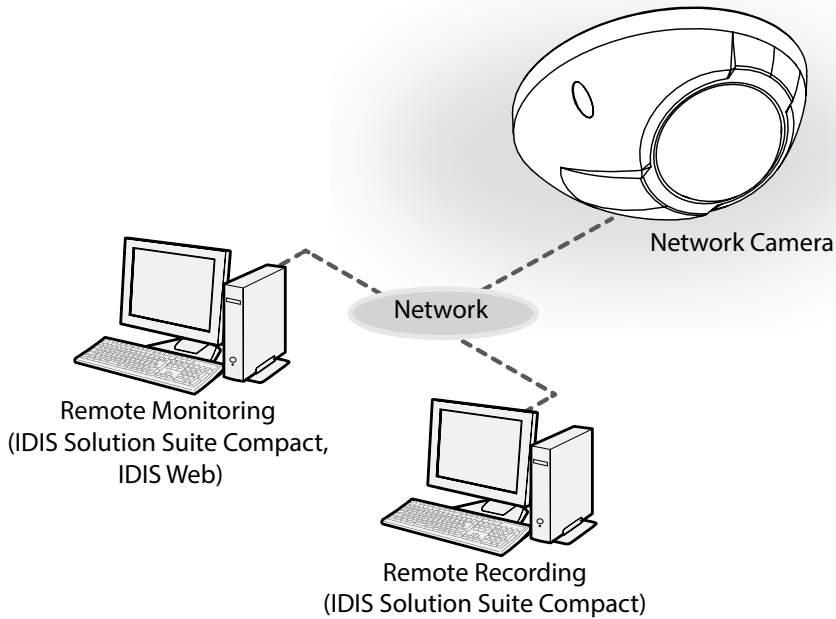

Control the camera over the network from software installed on a computer.
Ideal for using the camera over the network from a remote location.

The contents after page 13 are only for users using the camera with non DirectIP™ NVR connection or VMS connection such as IDIS Solution Suite Compact.

Part 3 - Remote Setup

Configure basic network camera settings and all other system settings.

✓ Screen images may vary depending on the model.

Camera Protocol

Camera supports **DirectIP™** and **IDIS** protocols.

- **DirectIP™** protocol:
 - Using with a DirectIP™ NVR enables camera use without the need to configure network settings.
 - The DirectIP™ NVR also allows you to control all camera settings directly from the NVR, without the need for a computer.

✓ For more information on configuring camera settings from a DirectIP™ NVR, refer to the DirectIP™'s **operation manual**.

- **IDIS** protocol:
 - Control the camera over the network from software installed on a computer or a separate NVR.
 - Ideal for using the camera over the network from a remote location.

Remote Setup

- 1 Launch the IDIS Discovery program and then from the main screen select a network camera whose protocol you wish to change.
- 2 Click on the **Setup** icon and then select **Setup** → **Protocol Setup**. A **Protocol Setup** screen will appear.
 - Alternatively, you can select **Network Camera** from the main screen and then right-click to access the **Protocol Setup** screen.

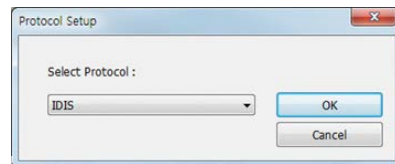
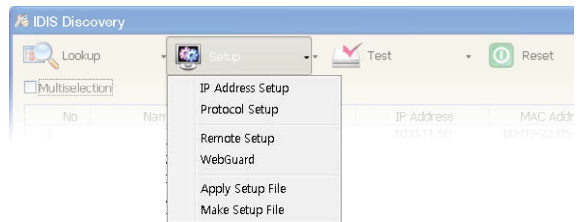

- 3 From the **Protocol Setup** screen, select the **IDIS** and then click OK.
- 4 Click on the **Setup** icon and then select **Setup** → **Remote Setup**. A **Remote Setup** screen will appear.
 - Alternatively, you can select **Network Camera** from the main screen and then right-click to access the **Remote Setup** screen.

- ✓ This operation manual has been composed based on IDIS protocol use.
- System settings can also be changed using a remote program.

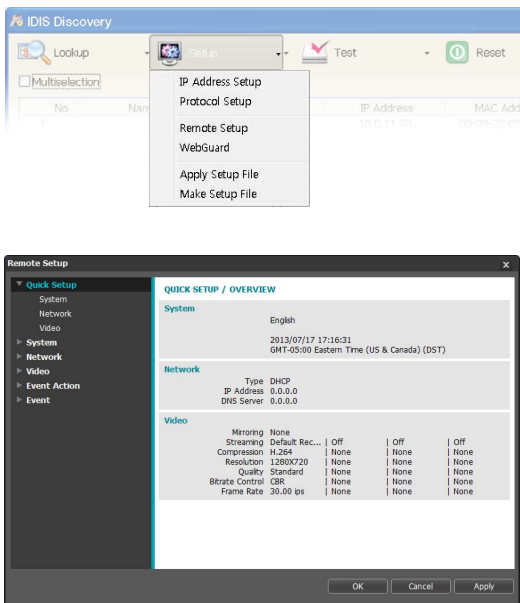

From the Remote Setup screen, select the menu on the left to display the current settings. Select an option under the menu to change the corresponding settings. Once you have changed the settings, click **OK** to apply the settings and exit from the Remote Setup screen.

Quick Setup

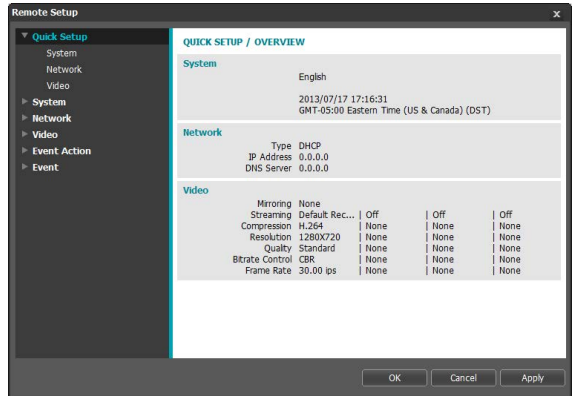

Quick Setup allows you to set up **System**, **Network**, **Video** and other basic settings needed for camera use.

System

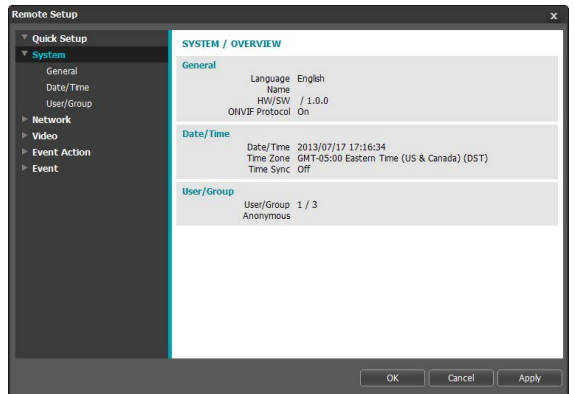

Change the camera's system information, add users/groups, and/or import/export settings.

General

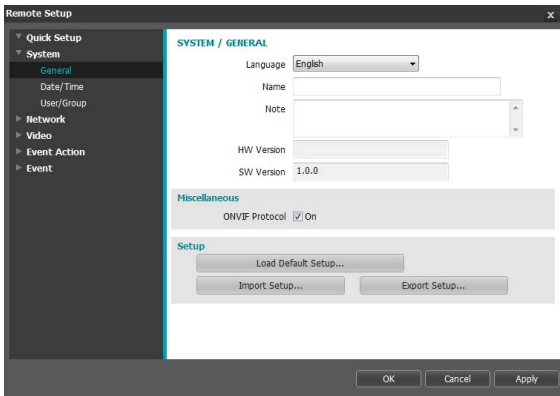

• SYSTEM/GENERAL

- **Language:** Select the language you wish to use for remote setup.
- **Name:** Enter a name for the camera. (Up to 31 alphanumeric characters, including spaces)
- **Note:** Enter a description for the camera.
- **HW Version/SW Version:** Indicates the camera's hardware and software versions.

• Miscellaneous

- **ONVIF Protocol:** Select to enable ONVIF protocol use. However, ONVIF Protocol is available only to users belonging to the standard user groups (**Administrator**, **Operator**, and **User**). When you have connected to the camera by using the ONVIF protocol, only the currently enabled streams or events are supported and you cannot change it. There may be some more settings that cannot be changed, too. If you want to change those settings, connect to the camera by using the IDIS Discovery program.

• Setup

- **Load Default Setup:** Restores all settings other than Date/Time to their factory defaults. Select Include Network Setup to load default network settings as well. For more information on network setup, refer to the **Network** on page 18.
- **Import Setup:** Open a setup file and apply its settings to the camera. Click on the button and then select a setup file. Select Include Network Setup to apply the file's network setup settings (exc. FEN). For more information on network setup, refer to the **Network** on page 18.
- **Export Setup:** Export the current settings as a .dat file. Click on the button and then enter a file name.



- **Load Default Setup** and **Import Setup** options are available only to users belonging to the **Administrator** group.
- When applying the settings of a setup file, do not select the **Include Network Setup** option if the network settings contained in the selected file is currently being used by a different camera. Doing so can interfere with establishing a connection with the other camera.
- If IP Address, Admin Port, and/or SSL settings have been changed, Remote Setup will terminate after applying the current settings.

Date/Time

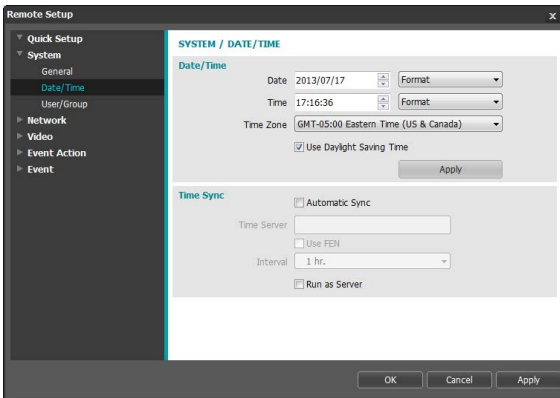

- **Date/Time:** Change the camera's date/time settings and display formats and configure the time zone and daylight saving time settings. Click **Apply** to apply the changes right away.
- **Time Sync**
 - **Automatic Sync:** Select to synchronize the system's time with the time server at a specified interval. Enter the time server's IP address or domain name and then specify the interval. If the time server is **FEN**-enabled, select the **Use FEN** option and then enter the time server's name instead of its IP address or domain name.
 - **Run as Server:** Select to run the camera as a time server. Other devices will then be able to synchronize its time setting with this camera's time setting.

If you wish to enter a domain name instead of an IP address for the **Time Server** setting, DNS server must be configured during **Network** setup. If you wish to enter a server name instead of an IP address or a domain name, the **Use FEN** option must be enabled during **Network** setup.

User/Group

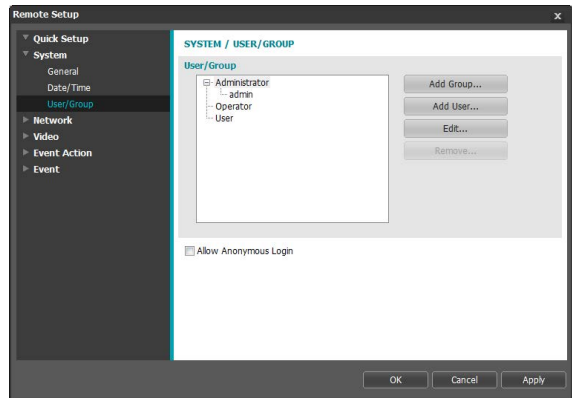

- **User/Group:** Change remote camera control permission settings for users and user groups.
 - **Add Group:** Add a new user group. Designate a name for the group and then specify control authorities.
 - **Add User:** Add a new user. Designate a name for the user, select which group to add the user to, and then enter a connection password.
 - **Edit:** Edit group authorities and/or user passwords. Select a group or user and then click on the button.
 - **Remove:** Delete groups or users. Select a group of user you wish to delete and then click on the button.
- **Allow Anonymous Login:** Select if you are using Webcasting. For more information on webcasting, refer to the **Webcasting** on page 26.

- **User/Group** settings can only be configured by users belonging to the **Administrator** group.
- There is no default password for the **Administrator** group's **admin** user.
 - Standard groups (**Administrator**, **Operator**, and **User**) cannot be edited or deleted. Authorities assigned here apply identically to ONVIF protocol user groups.
 - Group authorities that can be assigned are as follows:
 - **Upgrade:** Upgrade the system.
 - **Setup:** Configure the system's settings.
 - **Color Control:** Adjust the camera's brightness, contrast, saturation, and hue settings.
 - **System Check:** View system event status.

Network

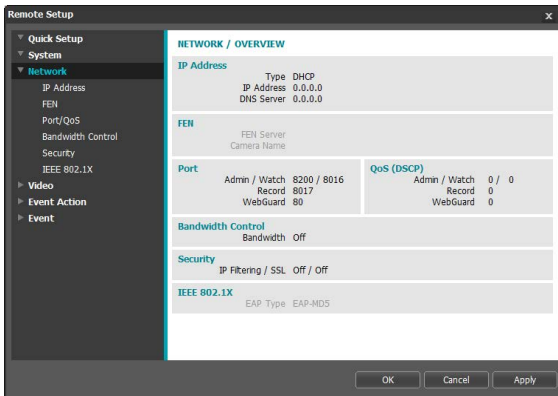

Change the network settings, enable FEN and security features, and control network bandwidth use.

IP Address

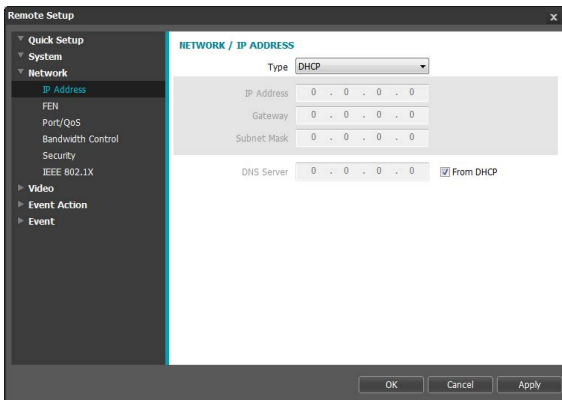

- **Type:** Select the type of network you are using. If this option has been changed, **Remote Setup** will terminate after applying the current settings.
 - **Manual:** Select if using a static IP. You will then be able to configure the related settings manually.
 - **DHCP:** Select if connected to the network using DHCP. Click **OK** to retrieve IP address and other network settings automatically from the DHCP server.
 - **ADSL (with PPPoE):** Select if connected to the network using ADSL. Enter the ID and password for ADSL connection and then click **OK** to log in and retrieve the IP address and other network settings automatically.

- **DNS Server:** Enter the DNS server's IP address. By using the DNS server, you will be able to use domain names instead of IP addresses when configuring the FEN, time, or SMTP server. If the camera is connected to the network via DHCP, select the **From DHCP** option to retrieve the DNS server's IP address from the DHCP server automatically. The updated address will be displayed upon the subsequent connection.



- Contact your network administrator for more information on the camera's network connection type, the DNS server's IP address, and other related information.
- If using DHCP or ADSL, the camera's IP address may change from time to time. We therefore recommend that you use the **FEN** feature.

FEN

Select **Use FEN** to enable the **FEN** feature.

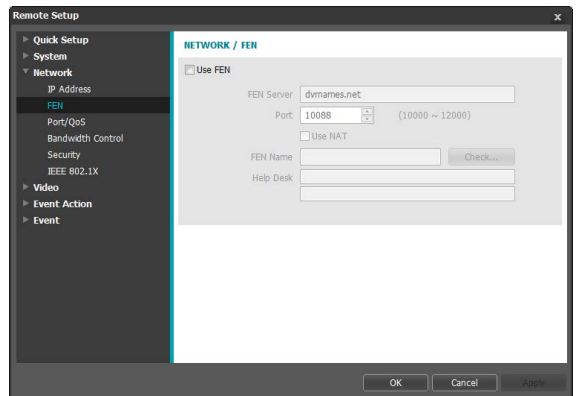

- **FEN Server:** Enter the FEN Server's IP address or domain name.
- **Port:** Enter the FEN Server's port number.
- **Use NAT:** Select if the camera is connected to the network via a router.
- **FEN Name:** Enter a camera name you wish to register to the FEN Server. Click **OK** to check the name's availability.

- **Help Desk:** Change the settings and then click **OK** to register the entered FEN name to the FEN Server. If all the settings have been configured correctly, the FEN Server's help desk information will be shown in the **Help Desk** fields next time you enter the **FEN** setup screen.



- Use **FEN** is a feature that allows you to register a unique name for a camera that utilizes a dynamic IP address to the FEN Server and connect to the camera using the registered name instead of an IP address, which can change from time to time. In order to use this feature, you must first register a FEN name to the FEN Server.
- If network settings have been changed, click **OK** at the bottom of the setup window to save the changes and then setup the **FEN**.
- Inquire with your network administrator for the **FEN Server's** IP address or domain name. If a DNS server has been configured under **Network** setup, you can enter the FEN Server's domain name instead of its IP address for the FEN Server setting.
- If using an IP router (or NAT), port configuration and other network functions will depend on the usage method of the IP router (or NAT).
- You will not be able to save **FEN** settings unless you click on the **OK** button next to the **FEN Name** field and check the entered name's availability. In addition, you will be prompted with an error message if you do not enter a FEN name or enter a name already registered to the FEN Server. If the FEN name contains the #, \, and/or % symbol, it might not be able to connect to the camera from the IDIS Web program.



The FEN Server operated by IDIS is a service to its clients and may go offline without notice for server update purposes or due to an unexpected failure.

Port/QoS

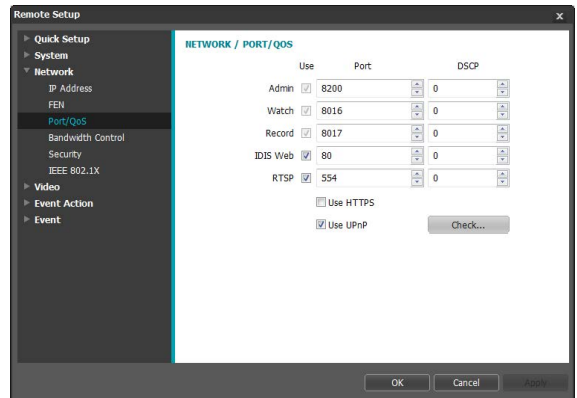

- **Use/Port:** Enable/disable ports and designate corresponding port numbers. **Admin, Watch** and **Record** ports are enabled by default and cannot be disabled. By enabling IDIS Web and RTSP ports, you will be able to use the IDIS Web program or a media player that supports RTSP (Real-Time Streaming Protocol) service to connect to the camera. If this option has been changed, **Remote Setup** will terminate after applying the current settings. (Applicable to **Admin** port number only.)
- **DSCP:** Designate each port's QoS (Quality of Service) level using DSCP values. Assigning QoS levels prioritizes the ports for network bandwidth use. Higher the DSCP value, higher the QoS level and thus higher on the network bandwidth allocation priority list. Use **0** if you do not want to assign a QoS level. The network environment must support DSCP in order for this feature to function properly. Contact your network administrator for more details.
- **Use HTTPS:** Select this option to apply https protocol-based security on IDIS Web.

- Use **UPnP**: If the camera is connected to the network via an IP router (or NAT), select this option to connect to the camera without setting up port forwarding. The IP router (or NAT) must be enabled with UPnP in order for this feature to function properly. For more information enabling UPnP on your IP router (or NAT), refer to the **IP router or NAT's operation manual**.

Click **Check** to test the current port settings. A confirmation message will appear if all the selected ports are available for use. If not, a list of recommended port numbers will be shown.

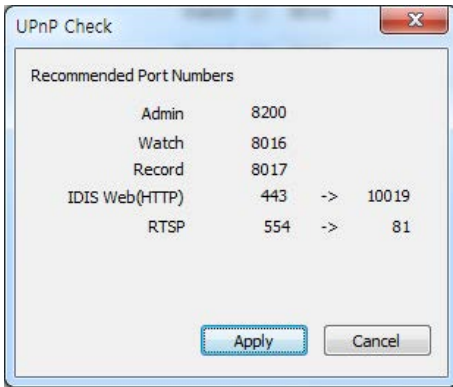

Click **Apply** to use the recommended port numbers.



- Each port number must be unique. Otherwise, you will not be able to connect to the camera from the remote program.
- You can connect to the camera using a media player that supports RTSP service and monitor its video feed. If the camera is connected to the network via an IP router (or NAT) or is behind a firewall, you must open the ports. (All ports if using UDP protocol and RTSP ports if using TCP protocol) This feature may not be supported by all media player. In addition, video display on certain media players may not be smooth depending on the network status, video streaming compression method used, and/or the resolution setting. Connection methods are as follows:
 - **Via PC**: Launch the media player (such as VLC) and then enter **rtsp://ID:Password@IP Address:RTSP Port Number/trackID='Stream Number'** (Stream Number: 1 if Primary, 2 if Secondary, and 3 if Tertiary). (e.g.: rtsp://admin:@10.0.152.35:554/trackID=1 (User: admin, Password: None, Camera IP Address: 10.0.152.35, RTSP Port Number: 554, Stream: Primary))
 - **Via Mobile Device**: Launch the web browser and then enter **http://IP Address:IDIS Web Port Number/** (If **Use HTTPS** has been enabled, enter **https** instead of **http**). Camera's IDIS Web port number and RTSP port number must be configured correctly in order to establish a connection this way.



- Port numbers of the remote program must be updated whenever the camera's port numbers are changed.
- ONVIF protocol may not function if using HTTPS.

Bandwidth Control

Regulates the camera's network bandwidth use based on network traffic fluctuations.

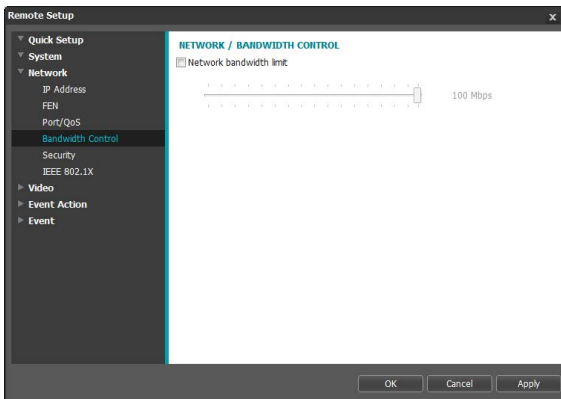

Select **Network Bandwidth limit** and then specify the maximum bandwidth. The camera will not be able to use more than the specified limit in the event of network traffic.



It may not be possible to produce the frame rate specified under **Video > Streaming** if a network bandwidth limit has been set.

Security

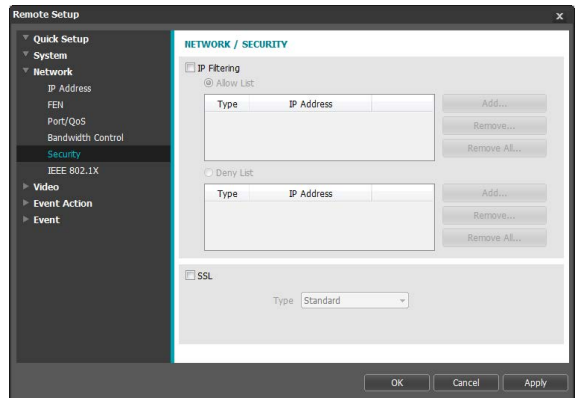

- **IP Filtering:** Select this option to enable IP Filtering. IP Filtering allows camera access from certain IP addresses and blocks access from others.
 - **Add:** Add new IP addresses to Allow List or Deny List. Select the **Host** option to add one IP address at a time. Select the **Group** option to define a range of IP addresses you wish to add.
 - **Remove/Remove All:** Remove individual or all IP addresses from Allow List or Deny List.
- **SSL:** Select this option to enable SSL (Secure Sockets Layer). Enabling this option applies SSL protocol protection on data transmitted out. However, programs and systems that do not support SSL will not be able to connect to the camera. If this option has been changed, Remote Setup will terminate after applying the current settings.
 - Time server, FEN Server, and SMTP server's IP addresses must be added to Allow List under **IP Filtering** in order to use Time Sync, FEN, and Send Email features. No connection to the camera will be permitted whatsoever from IP addresses added to **Deny List**.
 - Enabling the **SSL** option may place a greater load on the external system, depending on the level of security being used.
 - This product contains software developed by Open SSL Project for use in Open SSL Toolkit. (<http://www.openssl.org/>)

IEEE 802.1X

Select the **IEEE 802.1X** option to enable IEEE 802.1X network connection authentication.

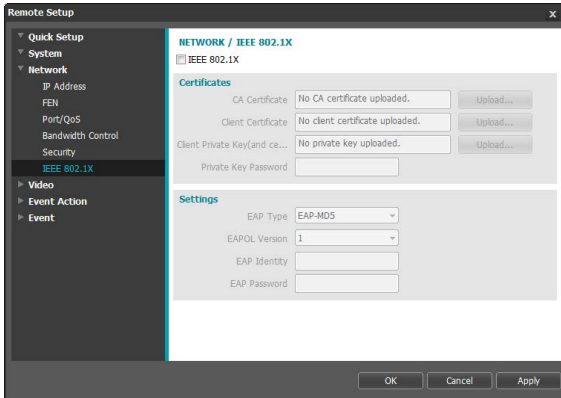

- **Certificates:** Upload a certificate or a private key. You may be prompted to enter a password for the private key.
- **Settings:** Configure EAP (Extensible Authentication Protocol) settings.
 - **EAP Type:** Choose a network connection authentication method. Selected method must be identical to the authentication method used on the authentication server.
 - **EAPOL Version:** Choose EAP authentication's version.
 - **EAP Identity/EAP Password:** Enter authentication ID and password.

The authentication server and AP must support IEEE 802.1X authentication in order for the IEEE 802.1X network connection authentication feature to function properly.

Video

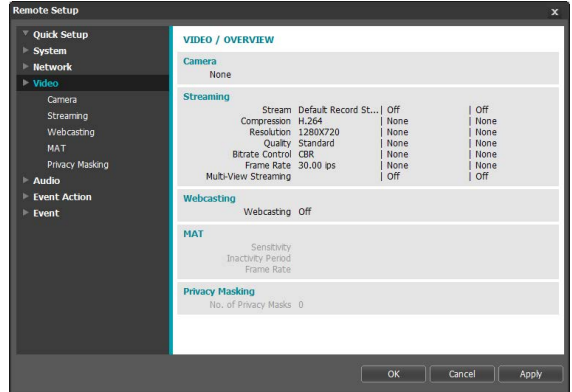

Configure **Camera, Streaming, Webcasting, MAT, and Privacy Masking** options.

Camera

Image Sensor

Configure **Image Sensor** settings.

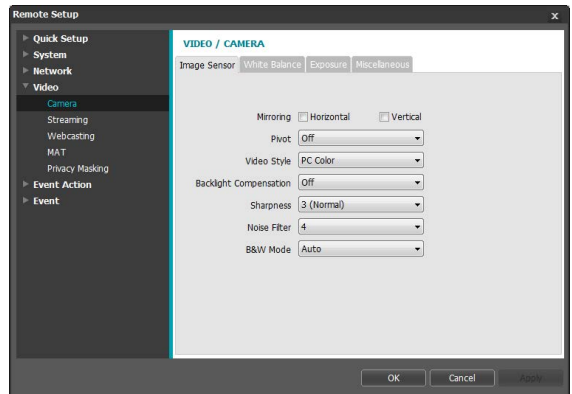

- **Mirroring:** Select Horizontal Reverse or Vertical Reverse to flip the image horizontally or vertically.
- **Pivot:** Select a direction to rotate images 90 degrees clockwise or counterclockwise. If vertical resolution is less than 320, this function is not supported. If you enable this function, you can monitor more efficiently long and narrow space such as hallways, corridors, etc. If both Mirroring and Pivot functions are enabled, Mirroring functions first, then Pivot.
- **Video Style:** Select **TV Color** or **PC Color**.

- **Backlight Compensation:** Enable/disable the Backlight Compensation feature. If enabled, objects are exposed brighter in backlit situations.
- **Sharpness:** Adjust the sharpness level. Adjust the contours to make the images look sharper. Increasing the value raises the sharpness level, but using too high a value can result in unwanted noise.
- **Noise Filter:** Select the noise filter level. Noise filter can reduce the noise in images taken under low-lighting conditions. Increasing the value reduces the noise, but using too high a value can result in blurry images.
- **3DNR:** Set whether to enable or disable 3DNR (3D Noise Reduction). When 3DNR is enabled, the level of background noise is reduced in low light conditions. It does not cause overall image blurring which might occur when using noise filter, but it may cause afterimage (lag). *DC-F1111 only*
- **B&W Mode:** When in the black and white mode, images are displayed in black and white and are clearer in low light conditions.
 - **Off, On:** Disables or enables the black and white mode.
 - **Auto:** Disables or enables the black and white mode automatically based on the conditions where the camera is installed.
- **INCANDESCENT - FLUORESCENT COLD:** Select a lighting type to apply the appropriate white balance.
- **Manual:** Adjust the white balance manually. Adjust Red and Blue gain values. Greater the value, greater the intensity of the corresponding color.

White Balance

Configure **White Balance** settings.

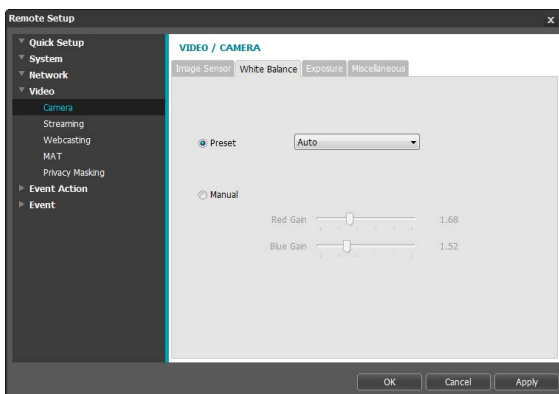

- **Preset:** Use preconfigured white balance settings.
 - **Auto:** Allow the system to adjust the white balance automatically. The system will assess the lighting conditions and adjust the white balance automatically.

Exposure

Configure **Exposure** settings.

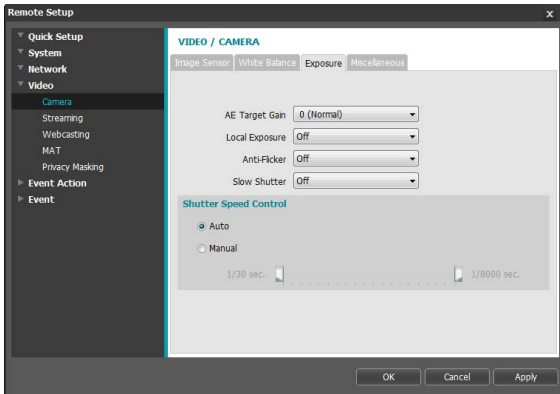

- **AE Target Gain:** Specify exposure compensation's target gain. Exposure is compensated automatically based on the specified target gain. Higher the gain, brighter the images.
- **Local Exposure:** Activate **Local Exposure**. Use Local Exposure on images that appear too dark due to backlighting conditions and on images containing over-exposed sections. Dark parking lot entrances and gas station entrances at night, for example (Local Exposure compensates for the bright light coming from incoming vehicle headlights and makes it possible to see the license plates). Greater the value, clearer the image.
- **Anti-Flicker:** If the lights in the area where the camera is located use alternating current, specify the frequency of the lights to minimize flickering. Matching the frequencies can reduce flickering. (NTSC: 60Hz, PAL: 50Hz)
- **Slow Shutter:** Activate **Slow Shutter**. The electronic shutter's speed will decrease to the specified level under low-lighting conditions to allow more light in and therefore produce brighter images.

- **Shutter Speed Control:** Adjust Shutter Speed. This option is available only when **Anti-Flicker** and **Slow Shutter** are both set to **Off**.
 - **Auto:** The system will assess the lighting conditions and adjust the shutter speed automatically.
 - **Manual:** Use the slider to select the desired shutter speed. Select the most suitable minimum and maximum shutter speeds for the lighting conditions in the area where the camera is located.



With certain features, selecting **Auto** automatically loads settings suitable for the camera's installation environment.

Miscellaneous

Configure **Miscellaneous** settings.

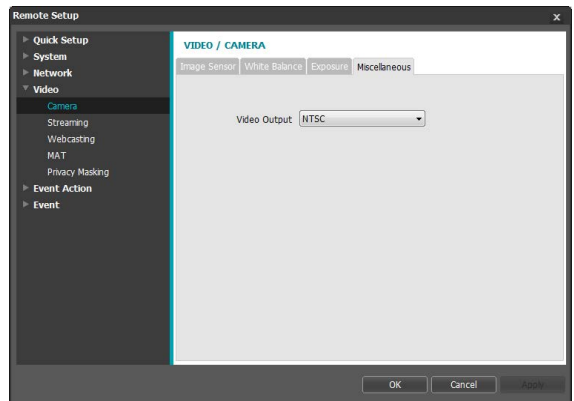

- **Video Output:** Select a video output signal format. The BNC video out may not work depending on the settings in the **Video > Streaming** menu.

Streaming

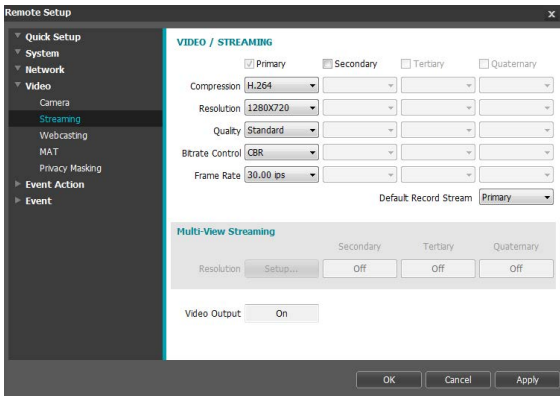

- **Primary/Secondary/Tertiary/Quaternary:** Multistreaming is supported. (priority: Primary > Secondary > Tertiary > Quaternary). Enable/disable streaming use. The lower stream settings may change depending on higher stream settings. The tertiary and quaternary streams may not be available depending on higher stream settings (refer to the table below).

DC-F1111

Primary		Secondary		Tertiary		Quaternary	
Resolution	ips	Resolution	ips	Resolution	ips	Resolution	ips
1280x720	30	1280x720	30	-	-	-	-

DC-F1211

Primary		Secondary		Tertiary		Quaternary	
Resolution	ips	Resolution	ips	Resolution	ips	Resolution	ips
1920x1080	30	1280x720	10	1280x720	1	-	-
1920x1080	30	1280x720	10	352x240	10	-	-
1920x1080	30	704x480	30	-	-	-	-
1920x1080	30	704x480	15	704x480	15	-	-
1920x1080	15	1920x1080	15	704x480	30	-	-
1920x1080	15	1280x720	30	1280x720	15	-	-

- **Compression:** Choose the streaming compression method.
- **Resolution:** Choose a resolution setting for video streaming. The resolution varies depending on the camera model. The current stream resolution cannot be higher than the higher stream resolution.
- **Quality:** Choose a quality setting for video streaming.

- **Bitrate Control:** Choose a bitrate control mode for H.264 compression.
 - **CBR (Fixed Bitrate):** Maintains the current bitrate regardless of motion change in the video.
 - **VBR (Variable Bitrate):** Bitrate varies depending on motion changes in the video. Less movement places less load on the network and takes up less storage space.
- **Frame Rate:** Choose a frame rate setting for video streaming. The frame rate of the current stream cannot be higher than the frame rate of the higher stream if those stream resolutions are same.
- **Default Record Stream:** Choose a stream to use for recording. This setting, however, may not apply if a recording stream has been designated from the remote program.

- **Multi-View Streaming:** Designate a specific area of the screen and stream images from that area only. (not supported for the primary stream) Click **Setup** to designate a streaming area.

Select **On** and then specify the streaming area's resolution.

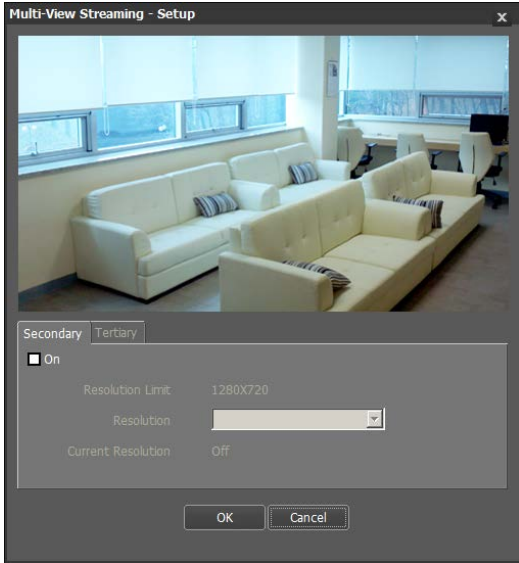

- **Resolution Limit:** Indicates the maximum resolution that can be set for the streaming area.
- **Resolution:** Designate a streaming area. Designated area is marked in red on the screen. You can adjust the resolution of the area or reposition the area by dragging and dropping using the mouse.
- **Current Resolution:** Displays the resolution of the designated streaming area.
- **Video Output:** Display whether the BNC video output works or not. The BNC video output may not work depending on the Streaming settings. *DC-F1211 only*

If multiple users are connected to the camera, the increase in bandwidth use can lower the frame rate.

Webcasting

Use the webcasting service to view live images from the camera on a web site.

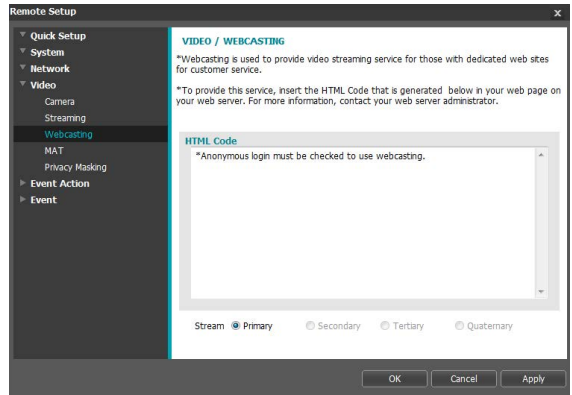

- **HTML Code:** Copy and paste the html code shown on the screen within the code of the web page you want the video to be displayed.
- **Stream:** Choose a stream to use for webcasting. Only a stream currently in use can be selected.

In order to use the webcasting service, the **Allow Anonymous Login** option under **System > User/Group** must be selected.

MAT

Select the **MAT** option to use the MAT (Motion Adaptive Transmission) feature during video transmission and recording.

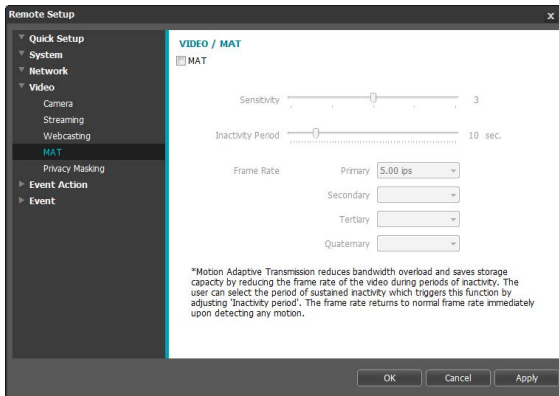

- **Sensitivity:** Set the motion detection sensitivity. Higher values will result in more sensitive motion detection.
- **Inactivity Period:** Set the Inactivity Period. If motion is not detected for the duration of time specified, video is transmitted and recorded using the frame rate designated below until movement is detected again.
- **Frame Rate:** Designate the frame rate to be used between the end of the Inactivity Period and the next motion detection. When the slow shutter mode is enabled under **Video > Camera** menu, the frame rate may change. Video is transmitted and recorded at the designated frame rate between the end of the Inactivity Period and the next motion detection. Once motion is detected again, the frame rate designated under **Streaming** is restored immediately.

MAT (Motion Adaptive Transmission) is a feature that lowers the frame rate when motion is not detected to reduce the load on the network and save on storage space. Based on the specified sensitivity setting, no movement will be assumed if there is no change between two consecutive images.

Privacy Masking

Select **Privacy Masking** to set up a privacy mask over a specific area. The section on which a privacy mask is applied will appear as black when monitoring video.

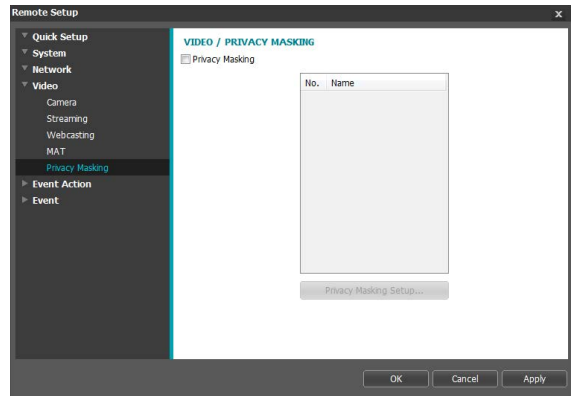

- **Privacy Masking Setup:** Set up privacy masks. (Up to 16)

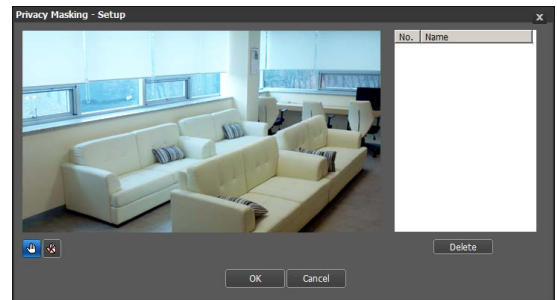

- **(Select)/(Unselect):** Set or remove a privacy mask. Click on the button and drag & drop using the mouse to set up a privacy mask.
- **No./Name:** Displays a list of active privacy masks. The numbers indicate privacy mask numbers. Select the empty space next to a number to assign a name to the corresponding privacy mask. Click **Delete** to remove the selected privacy mask.

Event Action

Designate event detection alert actions.

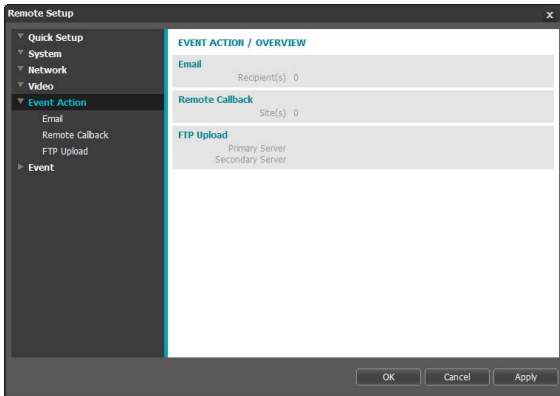

Email

Select **Email** to send out emails.

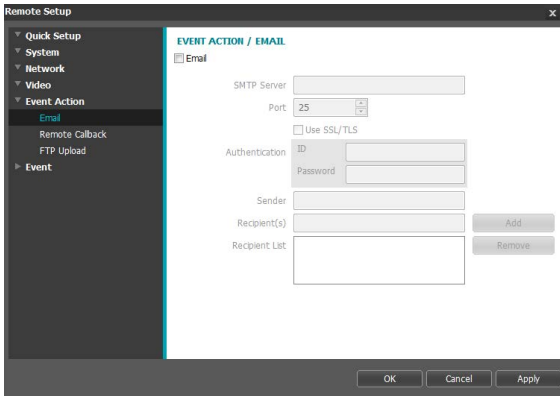

- **SMTP Server/Port:** Enter the SMTP server's IP address (or domain name) and port number you received from the network administrator. If a DNS server has been set up during network configuration, you can enter a domain name instead of an IP address. If using an SMTP server requiring an SSL connection, select the **Use SSL/TLS** option.
- **Authentication:** Enter a user ID and password if user authentication is required by the SMTP server.
- **Sender/Recipient(s):** Enter the sender and recipients' addresses. (Up to 10) The addresses must be properly formatted and include the @ symbol.

Remote Callback

Select **Remote Callback** to send callback messages to a remote system.



- Not supported from the IDIS Web program.
- The camera must be registered to the remote system in order to use the **Remote Callback** feature.

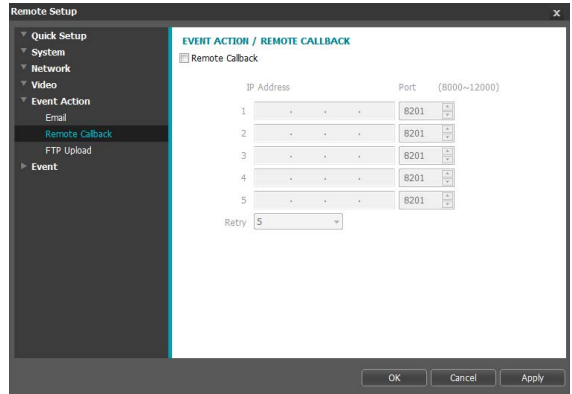

- **IP Address:** Enter the IP address and port number of the remote system that will receive the messages.
- **Retry:** Designate how many reattempts to make if message delivery fails.

FTP Upload

Select **FTP Upload** to upload .jpg image of the event detected to an FTP server.

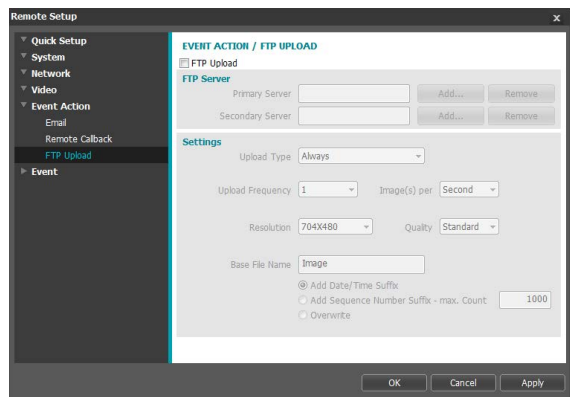

- **FTP Server:** Click **Add** to register a new FTP server. Click **Remove** to remove a registered FTP server. When an event is detected, a .jpg image of the event detected image is uploaded to the Primary Server. If the upload to the Primary Server fails, the file will be uploaded to the Secondary Server. Upload to the Secondary Server will continue to be attempted until successful. Fill out the fields below and click **Test** to test the FTP server connection settings. Once the test is complete, click **OK**.

- **FTP Server:** Enter the FTP server's IP address (or domain name).
 - **Upload Path:** Designate the file upload path.
 - **Port:** Enter the FTP server's port number.
 - **User ID, Password:** Enter the user ID and password needed for connecting to the FTP server.
- **Settings:** Configure image and upload settings.
 - **Upload Type:** Choose an upload type. Select **Always** to upload images using the settings below, irrespective of event detection. Select **Event** to upload images using the settings below when an event is detected.
 - **Upload Frequency:** Activated only when Upload Type has been set to **Always**. Designate the upload speed. The specified number of images will be uploaded to the FTP server during the specified period of time.
 - **Upload 1 image per:** Activated only when Upload Type has been set to **Event**. Designate the upload speed. Select **Upload** for and specify a duration. Images will be uploaded for the specified duration at the specified upload speed. Select **Upload while event status is active** to upload images at the specified speed only while event status is active.
 - **Resolution/Quality:** Choose the resolution and quality of the images to upload to the FTP server. Range of resolution settings you can use here can vary depending on the resolution setting applied under **Video > Streaming**.
 - **Base File Name:** Enter a name for the files to be uploaded to the FTP server and then choose file identification options. Select **Add Date/Time Suffix** to add event detection date and time information to each image file. Select **Add Sequence Number Suffix - max. Count** to number the image files based on the order of event detection. Select **Overwrite** to overwrite the previous image with the new image. Event type is automatically added to the file names.



- When specifying the **Upload Path** or **Base File Name**, you cannot use special characters such as \, /, #, *, |, :, ;, <, >, and ?.
- The resolution of FTP upload image can change depending on the resolution setting applied under **Video > Streaming**.
- Set speed settings for Upload Frequency and Upload 1 image per options in consideration of the FTP server's performance. FTP uploads can fail if the configured speed is higher than what the FTP server can handle.

Event

Configure event detection settings.

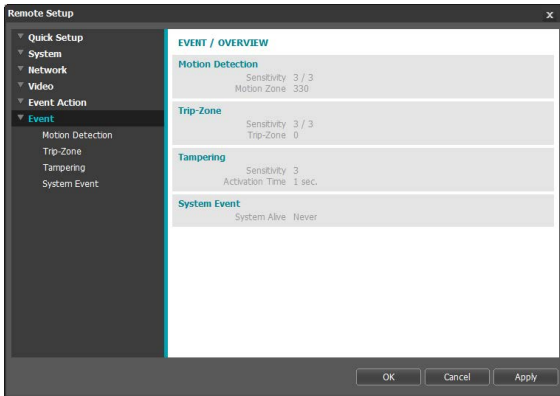

Motion Detection

Select **Motion Detection** to configure motion detection event settings. With motion detection event enabled, motion detections within the designated area will be assumed as events.

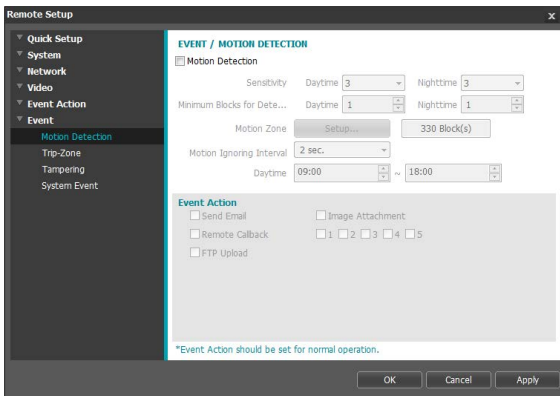

- **Sensitivity:** Select daytime and nighttime motion detection sensitivity levels. Higher values will result in more sensitive motion detection.
- **Minimum Blocks for Detection:** Select minimum blocks for daytime and nighttime motion detection. Motion must take place over the selected number of blocks in order for it to be considered as a motion detection event.

- **Motion Zone:** Click **Setup** and define the motion zone using blocks.
 - **(Select)**/ **(Unselect):** Enable/disable motion detection.
 - **(Single Block):** Select/unselect motion detection blocks individually.
 - **(Zone):** Select/unselect multiple motion detection blocks.
 - **(All):** Select/unselect all motion detection blocks.
- **Motion Ignoring Interval:** With Motion Ignoring Interval configured, no event log or notification is generated for motions detected during a period of time following a motion detection event.
- **Daytime:** Specify when daytime starts and ends. All other times will be assumed as nighttime.
- **Event Action:** Select a motion detection event alert action.
 - **Send Email:** Select if you wish to send an email. Select the **Image Attachment** option to attach a .jpg image of the event detected to the email.
 - **Remote Callback:** Select this option to send a message to a remote system and then select which system to send the message to.



- Not supported from the IDIS Web program.
- The camera must be registered to the remote system in order to use the **Remote Callback** feature.



Event Action settings must be configured correctly in order to perform event actions.

Trip-Zone

Select **Trip-Zone** to configure trip zone event settings. With trip zone event enabled, motion detected inside/outside the selected area will be assumed as an event.

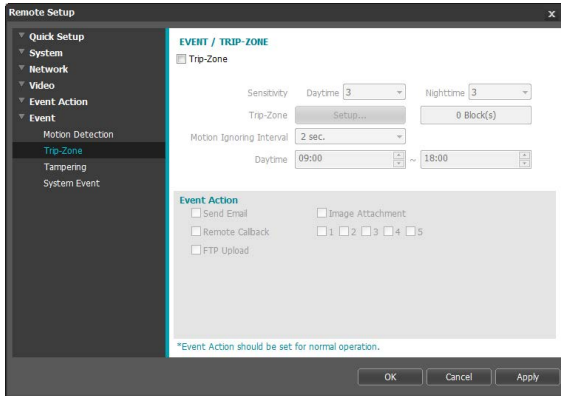

- **Sensitivity:** Select daytime and nighttime motion detection sensitivity levels. Higher values will result in more sensitive motion detection.
- **Trip-Zone:** Click **Setup** and define the trip zone using blocks.
 - (**Select**)/ (**Unselect**): Enable/disable trip zone.
 - (**Single Block**): Select/unselect trip zone blocks individually.
 - (**Zone**): Select/unselect multiple trip zone blocks.
 - (**All**): Select/unselect all trip zone blocks.
 - **Trip Direction:** Define in which direction the motion has to occur in order for it to be considered as an event. Select **In** for movement occurring from outside the trip zone in and **Out** for movement occurring from inside the trip zone out.
- **Motion Ignoring Interval:** With Motion Ignoring Interval configured, no event log or notification is generated for motions detected during a period of time following a motion detection event.
- **Daytime:** Specify when daytime starts and ends. All other times will be assumed as nighttime.

- **Event Action:** Select a trip zone event alert action.
 - **Send Email:** Select if you wish to send an email. Select the **Image Attachment** option to attach a .jpg image of the event detected to the email.
 - **Remote Callback:** Select this option to send a message to a remote system and then select which system to send the message to.
- **FTP Upload:** Select this option if you wish to upload images to the FTP server.



- Not supported from the IDIS Web program.
- The camera must be registered to the remote system in order to use the **Remote Callback** feature.



- **Event Action** settings must be configured correctly in order to perform event actions.

Tampering

Select **Tampering** to configure tampering detection event settings. With tampering detection event enabled, a sudden change in the video, such as due to movement of the camera or covering up of the lens, will be assumed as an event.

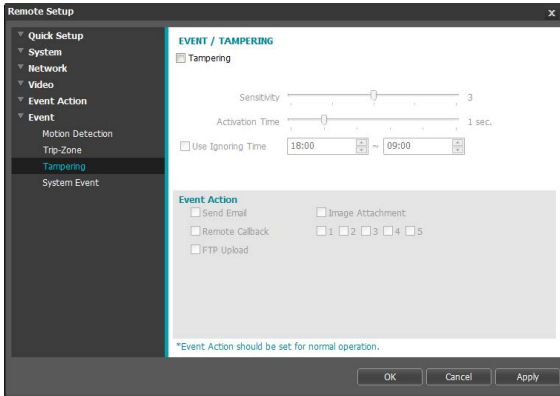

- **Sensitivity:** Define the tampering detection sensitivity. Higher values will result in more sensitive detection.
- **Activation time:** Specify how long tampering has to be detected for it to be considered as an event. Tampering detections that do not last for the specified duration of time will not be considered as events.
- **Use Ignoring Time:** Define the event ignoring time. Tampering detections taking place during the defined time range will not be assumed as events.
- **Event Action:** Select a tampering detection event alert action.
 - **Send Email:** Select if you wish to send an email. Select the **Image Attachment** option to attach a .jpg image of the event detected to the email.
 - **Remote Callback:** Select this option to send a message to a remote system and then select which system to send the message to.
 - Not supported from the IDIS Web program.
 - The camera must be registered to the remote system in order to use the **Remote Callback** feature.
 - **FTP Upload:** Select this option if you wish to upload images to the FTP server.

Event Action settings must be configured correctly in order to perform event actions.

System Event

Select **System Event** and configure system event settings. With system event enabled, system status will be checked periodically and corresponding alerts will be generated.

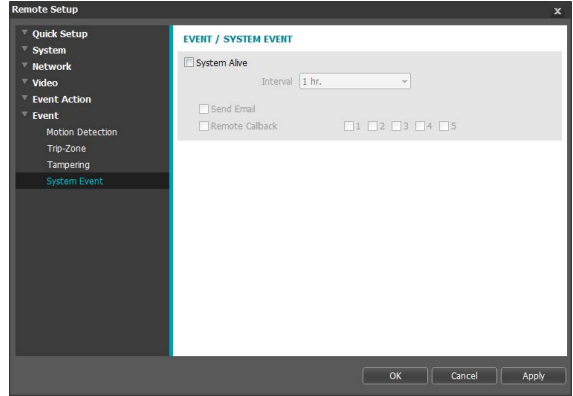

- **System Alive:** Select to check the system status and then set up a schedule.
 - **Send Email:** Select to send out an email when the system comes on line.
 - **Remote Callback:** Select this option to send a message to a remote system when the system comes on line and then select which system to send the message to.

• **Email** and **Remote Callback** settings under **Event Action** must be configured correctly in order to send out emails and messages.

Part 4 - IDIS Web

IDIS Web is a program that allows you to view video from remote locations over the Internet and can be accessed on a Microsoft Internet Explorer.

System requirements for running IDIS Web are as follows:

- OS: Microsoft® Windows® XP (Service Pack 3), Microsoft® Windows® Vista (Service Pack 1), Microsoft® Windows® 7 (Home Premium, Professional, Ultimate), Microsoft® Windows® 8 (Pro, Enterprise)
- CPU: Intel Pentium IV 2.4GHz or above (Core 2 Duo E4600 recommended)
- RAM: 1GB or more
- VGA: 128MB or more (1280x1024, 24bpp or above)
- Internet Explorer: Version 8.0 or later 32-bit

1 Launch Internet Explorer and then enter the following information in the address bar.

- http://IP Address:Port Number (IDIS Web connection port number selected during camera IP address and port number setup)
- Or http://FEN Server Address/FEN name (FEN Server address and FEN name registered to the FEN Server)
- Or http://web.idisglobal.com (it is required to enter the camera IP address when logging in. If the camera uses the FEN feature, you can enter the FEN name registered to the FEN server instead of the camera IP address after selecting the USE FEN option)



- If the Use HTTPS option has been selected during IDIS Web port number setup, enter https instead of http. If prompted with a security certificate warning, select "Continue to this website (not recommended)." If the IDIS Web login page fails to load, configure Internet Explorer's settings as follows:
 - Tools → Internet Options → Security → Custom Level... → Medium-high (default) or Medium.
 - Tools → Internet Options → Advanced → Security → Use TLS 1.0 (select)
- If connecting by entering an IP address and a port number, you can connect by entering just the IP address if IDIS Web connection port number has been set to 80 (443 when entering https).
- If connecting by entering http://web.idisglobal.com, it is required to enter the Watch port number.
- Contact your network administrator for the IP address of the camera you wish to connect to the the IDIS Web port number.

2 When prompted with the IDIS Web login window, select **LIVE-PORT** or **PLAY-PORT** as the desired mode. Enter the ID and password and click **LOGIN** to sign in using the selected mode.

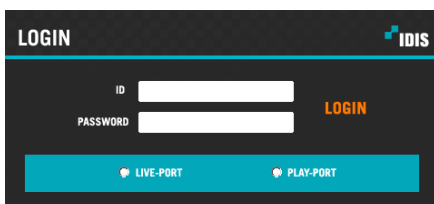







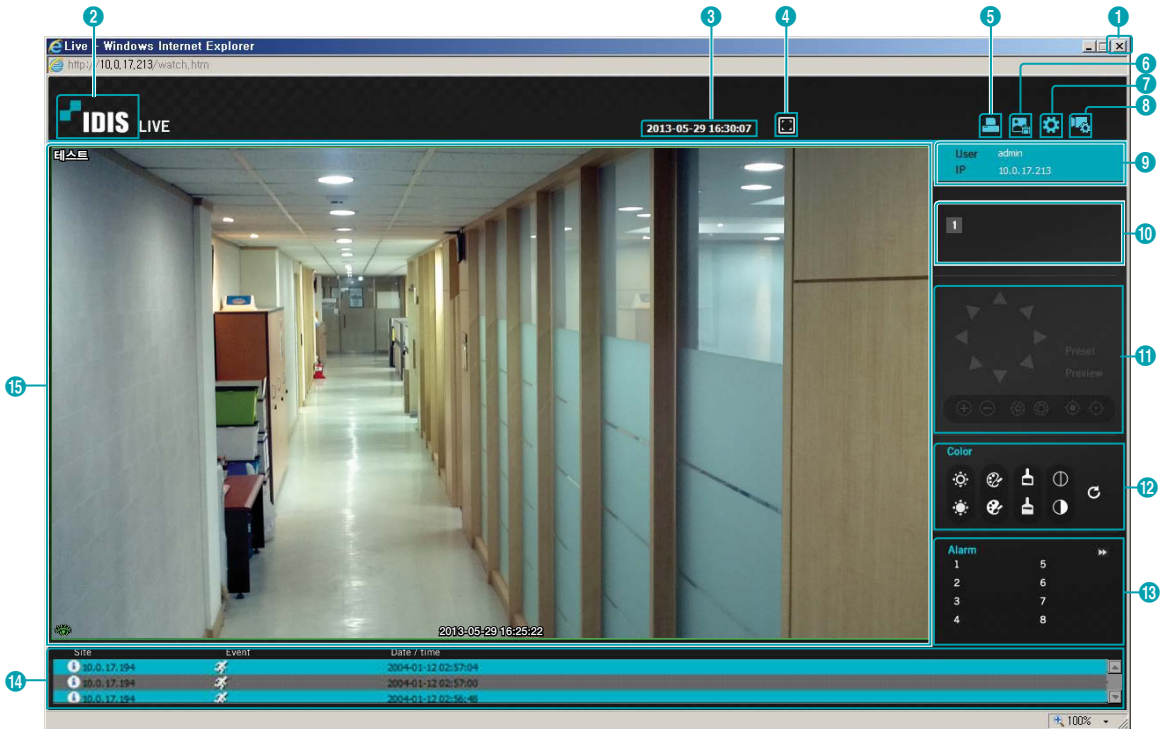







- ☑ • IDIS Web supports Microsoft Internet Explorer only and no other type of web browser.
- IDIS Web does not work with Microsoft® Windows® 8 metro UI.
- To use IDIS Web on Microsoft Windows Vista or above, launch Internet Explorer by right-clicking on the icon and selecting the **Run as administrator** option. Otherwise, certain IDIS Web functions might not be available.
- Launching a new version of IDIS Web for the first time can cause Internet Explorer to load information from the previous version. In this case, navigate to **Tools** → **Internet Options** → **General**, delete temporary Internet files, and then restart IDIS Web.
- On Microsoft Windows Vista or above, lowered image transmission rate can prevent the screen from being displayed or updated. In this case, we recommend that you disable the computer's auto tuning function. Open the command prompt as an administrator. (**Start** → **Accessories** → **Command Prompt** → **Right-Click** and then select **Run as administrator**) Type in "**netsh int tcp set global autotuninglevel=disable**" and then press Enter. Restart the computer to apply the change. To enable auto tuning again, launch the command prompt as an administrator and then type in "**netsh int tcp set global autotuninglevel=normal**". Restart the computer to apply the change.

Web Live Mode

A remote web monitoring program that allows you to monitor images from remote locales in real-time.



①	Press ⓧ to terminate IDIS Web.
②	Place the mouse pointer on the IDIS logo to check IDIS Web's version.
③	Displays the current time.

4	Click  to view the video in full screen. Press the ESC key on the keyboard to return to the previous screen.							
5	Click  to print the current video screen using a printer connected to the computer.							
6	Click  to save the current video screen as an image file.							
7	Click  to configure rendering mode and OSD settings. Select rendering mode to adjust the video output rate or select which OSD elements to display on the screen from the OSD list.							
8	Click  to load the camera setup window.							
9	Shows login information.							
10	Indicates the camera's number.							
11	This function is not supported.							
12	Used to adjust live video quality.							
13	This function is not supported.							
14	Event status window at the bottom of the screen displays a list of events detected at remote locales.							
	<table border="1" data-bbox="185 801 1262 883"> <tr> <td data-bbox="185 801 314 841"></td> <td data-bbox="314 801 719 841">Motion Detection</td> <td data-bbox="719 801 848 841"></td> <td data-bbox="848 801 1262 841">Tampering</td> </tr> <tr> <td data-bbox="185 841 314 883"></td> <td data-bbox="314 841 719 883">Trip zone</td> <td data-bbox="719 841 848 883"></td> <td data-bbox="848 841 1262 883"></td> </tr> </table>		Motion Detection		Tampering		Trip zone	
	Motion Detection		Tampering					
	Trip zone							
15	<p>Right-click on the screen to display the pop-up menu.</p> <ul style="list-style-type: none"> • Change Camera Title: Used to change the camera's name. <div data-bbox="1018 915 1233 1092" style="border: 1px solid gray; padding: 5px; margin-left: 20px;"> <div data-bbox="1045 925 1200 967">Change Camera Title Enable Audio</div> <hr/> <div data-bbox="1045 986 1223 1009">Aspect Ratio ▶</div> <hr/> <div data-bbox="1045 1028 1223 1051">MultiStream ▶</div> <hr/> <div data-bbox="1045 1070 1193 1092">Anti-Aliasing Screen</div> </div> <input checked="" type="checkbox"/> Renaming the camera in Web Live mode does not affect the camera's name on the remote system. If no name is entered for the camera, the name used at the remote locale is shown on the screen. • Aspect Ratio: Change the aspect ratio of the video displayed on the screen. <ul style="list-style-type: none"> - Fit to Screen: Fit the video to the size of the camera screen. - Fit to Aspect Ratio: Resizes camera screen to original aspect ratio of the video. - Half Size (x0.5) - 4 Times Bigger (x4): Displays the camera videos in the selected size based on the original size of the video. For example, original size (x1) displays the video in its original size. Half size (x0.5) through 4 times larger (x4) options are only available if there is enough space on the camera screen to accommodate the selected size. • MultiStream: If the camera is running on multi-stream mode, you can choose between the streams. • Anti-Aliasing Screen: Removes stair step effect (blocks) that are caused when zooming a video to improve overall quality of video output. 							

Part 5 - Appendix

Setup Menu Tree (Remote Setup)

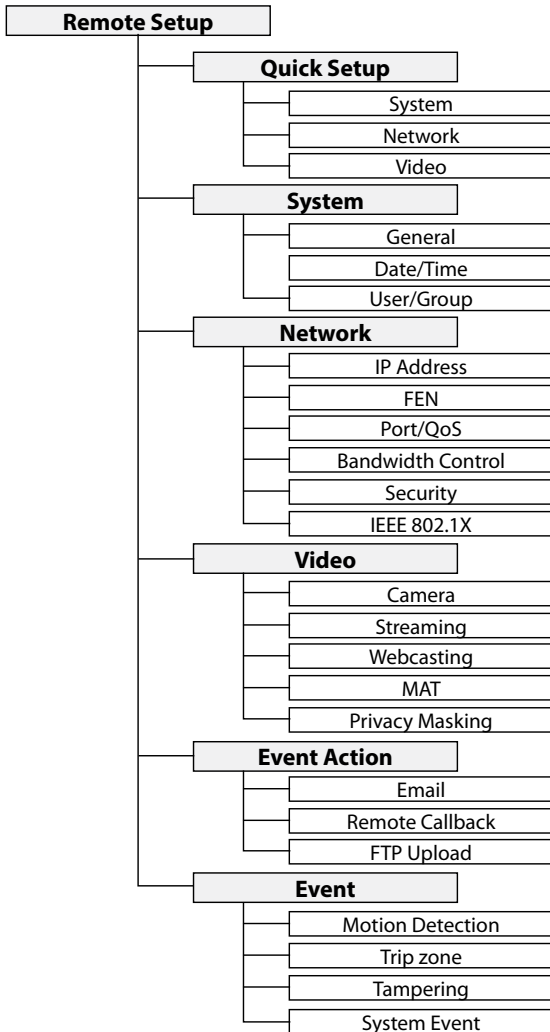

Troubleshooting

Problem	Check
The main unit won't turn on.	<ul style="list-style-type: none"> • Check the power cable connection. • Check the power outlet.
PoE switch isn't being recognized.	Check the grounding status of the I/O device connected to the camera and the PoE switch. If they are not grounded, ground them and try again.
I can't see Live videos.	<ul style="list-style-type: none"> • Check the camera's power status. • Check the network connection status of the computer and the network camera.
Images are blurry.	<ul style="list-style-type: none"> • Make sure the lens is clean. If not, clean it using a soft piece of cloth or a brush. • If there is too much light coming into the camera or the camera is picking up an overly bright light source, adjust the camera's position/angle accordingly.
Video color appears incorrect.	Check the white balance settings. If using the Auto option, it may take some time for the white balance to be adjusted.
Images are blinking.	If the camera is pointed at the sun or a fluorescent lamp, adjust the camera's angle away.
Lost the admin ID and password and unable to connect to a network camera.	You must perform a factory reset. A factory reset will revert all settings, including network settings, to their factory defaults. After performing a factory reset, make a memo of the admin ID and password as a safety precaution.
Unable to launch IDIS Web.	If the IDIS Web login screen is not loading, check which version of Microsoft Internet Explorer you are using. IDIS Web may not launch properly on versions 6.0 or below.

Specifications



These product specifications may change without prior notice.

Lens

Lens Type	Fixed Focus Lens: F2.0	
Focal Length	4.0mm	
Viewing Angle	DC-F1111	65.8°(H), 35.9°(V), 76.9°(D)
	DC-F1211	106.3°(H), 61.9°(V), 125.3°(D)

Camera

Image Sensor	DC-F1111	1/4" CMOS
	DC-F1211	1/2.7" CMOS
Minimum Subject Lux	DC-F1111	When the B&W mode is disabled: 0.26 Lux @ F 2.0 When the B&W mode is enabled: 0.23 Lux @ F 2.0 When the B&W mode is enabled and shutter speed is 1/7.5s: 0.03 Lux @ F 2.0
	DC-F1211	When the B&W mode is disabled: 0.69 Lux @ F 2.0 When the B&W mode is enabled: 0.59 Lux @ F 2.0 When the B&W mode is enabled and shutter speed is 1/7.5s: 0.11 Lux @ F 2.0
Scanning Method	Progressive scan	
Signal-to-Noise Ratio	> 45 dB	
Dynamic Range (Digital WDR)	> 90 dB	

Video

Signal Format	NTSC or PAL (programmable)	
Compression Algorithm	H.264, M-JPEG (Four levels)	
Compression Resolution	DC-F1111	352x240, 704x480, 1280x720
	DC-F1211	352x240, 704x480, 1280x720, 1920x1080
Bitrate Control	DC-F1111	H.264 –CBR / VBR (up to 8 Mbps)
	DC-F1211	H.264 –CBR / VBR (up to 12 Mbps)
Max. Transmission Rate (frames per second)	DC-F1111	30 ips @ 1280x720 + 30 ips @ 1280x720
	DC-F1211	30 ips @ 1920x1080 + 4 ips @ 1920x1080
Multi-Stream	Primary, Secondary, Tertiary, Quaternary	

I/O

Video Out*	1 Composite, 1 Vp-p
Network Connection	10/100 Mbps Ethernet

* Use these ports for previewing video and not monitoring video.

Connector

Video Out**	BNC
Ethernet Port	RJ-45

** Use these ports for previewing video and not monitoring video.

General

External Dimensions (W x H x D)	3.74" x 2.21 x 4.72" (95mm x 56.21mm x 120mm)
Packaging Dimensions (W x H x D)	7.64" x 4.45" x 5.87" (194mm x 113mm x 149mm)
Weight (Main Unit)	0.55 lbs. (0.25kg)
Weight (Packaging)	0.95 lbs. (0.43kg)
Working Temperature	14°F to 122°F (-10°C to 50°C) (Starting temperature: 32°F to 122°F (0°C to 50°C))
Operating Humidity	0% ~ 90%
Power Input	PoE(IEEE 802.3af, Class1)
Power Consumption	Max. 3W
Certifications	FCC, CE

Index

A		O	
Admin Port	19	ONVIF Protocol	16
B		Q	
Bitrate Control	25	Quality	25
C		R	
Camera Name	16	Record Port	19
Compression	25	Resolution	25
D		RTSP Port	19
Date/Time	17	S	
DSCP	19	SSL	21
F		T	
FEN Name	18	Time Sync	17
FEN Server	18	U	
Frame Rate	25	Use FEN	18
I		Use HTTPS	19
IDIS Web Port	19	User/Group	17
IPFiltering	21	Use UPnP	20
M		W	
MAT	27	Watch Port	19
N			
Network Bandwidth Limit	21		



IDIS Co., Ltd.

For more information, please visit at
www.idisglobal.com