



DC-B Series

Installation Manual

DC-B4501X



DC-B4501X-A

Before reading this manual



This is a basic installation manual for use of an IDIS network camera. Users who are using this product for the first time, as well as users with experience using comparable products, must read this manual carefully before use and heed to the warnings and precautions contained herein while using the product. Safety warnings and precautions contained in this manual are intended to promote proper use of the product and thereby prevent accidents and property damage and must be followed at all times. Once you have read this manual, keep it at an easily accessible location for future reference.

-  • The manufacturer will not be held responsible for any product damage resulting from the use of unauthorized parts and accessories or from the user's failure to comply with the instructions contained in this manual.
- The information in this document is believed to be accurate as of the date of publication. The manufacturer is not responsible for any problems resulting from the use thereof. The information contained herein is subject to change without notice. Revisions or new editions to this publication may be issued to incorporate such changes.
- It is recommended that first-time users of this network camera and individuals who are not familiar with its use seek technical assistance from their retailer regarding product installation and use.
- If you need to disassemble the product for functionality expansion or repair purposes, you must contact your retailer and seek professional assistance.
- Both retailers and users should be aware that this product has been certified as being electromagnetically compatible for commercial use. If you have sold or purchased this product unintentionally, please replace with a consumer version.

Safety Symbols

Symbol	Type	Description
	IEC60417, No.5031	Direct current
	IEC60417, No.5032	Alternating current

In-Text

Symbol	Type	Description
	Caution	Important information concerning a specific function.
	Note	Useful information concerning a specific function.

Safety Precautions

WARNING

RISK OF ELECTRIC SHOCK
DO NOT OPEN

WARNING: TO REDUCE THE RISK OF ELECTRIC SHOCK,
DO NOT REMOVE COVER (OR BACK).
NO USER-SERVICEABLE PARTS INSIDE.
REFER SERVICING TO QUALIFIED SERVICE PERSONNEL.

Important Safeguards

1. Read Instructions

All the safety and operating instructions should be read before the appliance is operated.

2. Retain Instructions

The safety and operating instructions should be retained for future reference.

3. Cleaning

Unplug this equipment from the wall outlet before cleaning it. Do not use liquid aerosol cleaners. Use a damp soft cloth for cleaning.

4. Attachments

Never add any attachments and/or equipment without the approval of the manufacturer as such additions may result in the risk of fire, electric shock or other personal injury.

5. Water and/or Moisture

Do not use this equipment near water or in contact with water.

6. Placing and Accessories

Do not place this equipment on an wall or ceiling that is not strong enough to sustain the camera. The equipment may fall, causing serious injury to a child or adult, and serious damage to the equipment. Wall or shelf mounting should follow the manufacturer's instructions, and should use a mounting kit approved by the manufacturer.



This equipment and cart combination should be moved with care. Quick stops, excessive force, and uneven surfaces may cause the equipment and cart combination to overturn.

Do not place this equipment in an enclosed space. Sufficient ventilation is required to prevent an increase in ambient temperature which can cause malfunction or the risk of fire.

7. Power Sources

This equipment should be operated only from the type of power source indicated on the marking label. If you are not sure of the type of power, please consult your equipment dealer or local power company.

You may want to install a UPS (Uninterruptible Power Supply) system for safe operation in order to prevent damage caused by an unexpected power stoppage. Any questions concerning UPS, consult your UPS retailer.

This equipment should be remain readily operable.

8. Power Cord

Operator or installer must remove power and TNT connections before handling the equipment.

9. Lightning

For added protection for this equipment during a lightning storm, or when it is left unattended and unused for long periods of time, unplug it from the wall outlet and disconnect the antenna or cable system. This will prevent damage to the equipment due to lightning and power-line surges. If thunder or lightning is common where the equipment is installed, use a surge protection device.

10. Overloading

Do not overload wall outlets and extension cords as this can result in the risk of fire or electric shock.

11. Objects and Liquids

Never push objects of any kind through openings of this equipment as they may touch dangerous voltage points or short out parts that could result in a fire or electric shock. Never spill liquid of any kind on the equipment.

12. Servicing

Do not attempt to service this equipment yourself. Refer all servicing to qualified service personnel.

13. Damage requiring Service

Unplug this equipment from the wall outlet and refer servicing to qualified service personnel under the following conditions:

- When the power-supply cord or the plug has been damaged.
- If liquid is spilled, or objects have hit the equipment.
- If the equipment has been exposed to rain or water.
- If the equipment does not operate normally by following the operating instructions, adjust only those controls that are covered by the operating instructions as an improper adjustment of other controls may result in damage and will often require extensive work by a qualified technician to restore the equipment to its normal operation.
- If the equipment has been dropped, or the cabinet damaged.
- When the equipment exhibits a distinct change in performance — this indicates a need for service.

14. Replacement Parts

When replacement parts are required, be sure the service technician has used replacement parts specified by the manufacturer or that have the same characteristics as the original part. Unauthorized substitutions may result in fire, electric shock or other hazards.

15. Safety Check

Upon completion of any service or repairs to this equipment, ask the service technician to perform safety checks to determine that the equipment is in proper operating condition.

16. Field Installation

This installation should be made by a qualified service person and should conform to all local codes.

17. Correct Batteries

Warning: Risk of explosion if battery is replaced by an incorrect type. Replace only with the same or equivalent type.

Dispose of used batteries according to the instructions.

The battery shall not be exposed to excessive heat such as sunshine, fire or the like.

18. Tmra

A manufacturer's maximum recommended ambient temperature (Tmra) for the equipment must be specified so that the customer and installer may determine a suitable maximum operating environment for the equipment.

FCC Compliance Statement

THIS EQUIPMENT HAS BEEN TESTED AND FOUND TO COMPLY WITH THE LIMITS FOR A CLASS A DIGITAL DEVICE, PURSUANT TO PART 15 OF THE FCC RULES. THESE LIMITS ARE DESIGNED TO PROVIDE REASONABLE PROTECTION AGAINST HARMFUL INTERFERENCE WHEN THE EQUIPMENT IS OPERATED IN A COMMERCIAL ENVIRONMENT. THIS EQUIPMENT GENERATES, USES, AND CAN RADIATE RADIO FREQUENCY ENERGY AND IF NOT INSTALLED AND USED IN ACCORDANCE WITH THE INSTRUCTION MANUAL, MAY CAUSE HARMFUL INTERFERENCE TO RADIO COMMUNICATIONS. OPERATION OF THIS EQUIPMENT IN A RESIDENTIAL AREA IS LIKELY TO CAUSE HARMFUL INTERFERENCE, IN WHICH CASE USERS WILL BE REQUIRED TO CORRECT THE INTERFERENCE AT THEIR OWN EXPENSE.

WARNING: CHANGES OR MODIFICATIONS NOT EXPRESSLY APPROVED BY THE PARTY RESPONSIBLE FOR COMPLIANCE COULD VOID THE USER'S AUTHORITY TO OPERATE THE EQUIPMENT. THIS CLASS OF DIGITAL APPARATUS MEETS ALL REQUIREMENTS OF THE CANADIAN INTERFERENCE CAUSING EQUIPMENT REGULATIONS.

WEEE (Waste Electrical & Electronic Equipment)

Correct Disposal of This Product

(Applicable in the European Union and other European countries with separate collection systems)



This marking shown on the product or its literature, indicates that it should not be disposed with other household wastes at the end of its working life. To prevent possible harm to the environment or human health from uncontrolled waste disposal, please separate this from other types of wastes and recycle it responsibly to promote the sustainable reuse of material resources.

Household users should contact either the retailer where they purchased this product, or their local government office, for details of where and how they can take this item for environmentally safe recycling.

Business users should contact their supplier and check the terms and conditions of the purchase contract. This product should not be mixed with other commercial wastes for disposal.

Copyright

© 2021 IDIS Co., Ltd.

IDIS Co., Ltd. reserves all rights concerning this manual.

Use or duplication of this manual in part or whole without the prior consent of IDIS Co., Ltd. is strictly prohibited.

Contents of this manual are subject to change without prior notice for reasons such as functionality enhancements.

Registered Trademarks

IDIS is a registered trademark of IDIS Co., Ltd.

Other company and product names are registered trademarks of their respective owners.

The information in this manual is believed to be accurate as of the date of publication even though explanation about some functions may not be incorporated. We are not responsible for any problems resulting from the use thereof. The information contained herein is subject to change without notice. Revisions or new editions to this publication may be issued to incorporate such changes.

The software included in this product contains some Open Sources. You may obtain the corresponding source code which we have to distribute according to the license policy. For more information, refer to **System > General** page. This product includes software developed by the University of California, Berkeley and its contributors, and software developed by the OpenSSL Project for use in the OpenSSL Toolkit (<http://www.openssl.org/>). Also, this product includes cryptographic software written by Eric Young (eyay@cryptsoft.com).

Table of Contents

1

Part 1 – Introduction.....	6
Product Features	6
Accessories.....	7
Overview	8
Front	8
Side	8
Top, Bottom.....	8
Back	9
Installation	11
Manual Iris Lens	12
DC Type/P Type Auto Iris Lens.....	12
CS-Mount Lens.....	12
C-Mount Lens	13
Dimensions	13

2

Part 2 - Camera Connection	14
With DirectIP™ NVR-based Layout.....	14
With non DirectIP™ NVR-based Layout	15

3

Part 3 - Appendix.....	16
Troubleshooting	16
Specifications	17

Part 1 – Introduction

Product Features

DC-B4501X/DC-B4501X-A is an IP-based network camera that compresses and transmits video over ethernet. You can use the IDIS Discovery program to change network camera settings or the IDIS Solution Suite Compact program to manage multiple network cameras. In addition, the embedded web server (IDIS Web) lets you remotely view live video or scan recorded video using a web browser. Alternatively, you can use the provided remote access program to manage network cameras and view/record video.



In this manual, the term **Remote System** refers to the computer on which the remote program (IDIS Solution Suite Compact or IDIS Web) is running.

- Supports DirectIP mode working with a DirectIP™ NVR that allows users to simply set up all required configurations without a PC
- Supports ONVIF protocol (Core specification version 16.12)
- Multi-streaming for high-resolution and high-quality video monitoring and simultaneous recording in real-time as well as flexible configurations for those
- Supports H.265, H.264 video compression and M-JPEG still image compression algorithms
- Supports 4-stage video compression rate and multiple compression resolutions
- Bidirectional audio communication support for remote audio dialog *DC-B4501X model only*
- Video stream buffering to counter pre-/post-event buffering and network delays for improved network recording reliability
- Remote monitoring via web browser or remote software
- Automatic web casting code (HTML) generation
- Up to 10 simultaneous remote connections

- IP filtering, HTTPS, SSL, IEEE 802.1X, and configurable user authority levels for greater security
- Network bandwidth limitation and MAT features for more efficient use of network bandwidth
- Easy network access via UPnP (Universal Plug and Play) function and embedded mDNS (Multicast DNS) protocol
- Wide dynamic range compensation (True WDR) for improved video quality in high-contrast situations
- Slow shutter support for improved low-lighting video capture performance
- Day & Night feature (built-in IR cut filter changer)
- Quick and easy firmware upgrade over the network
- Redundant firmware and auto recovery features for improved system stability
- Network-based integrated management of multiple network cameras
- Multiple event detection modes: Alarm-in, motion detection, trip zone, audio detection, and tampering
- Backup storage on a microSD memory card as a safeguard against data loss during network interruptions
- Supports 12 VDC and PoE (Power over Ethernet)
- Supports pan/tilt driver control via RS485 interface
- Supports C/CS mount lens connection
- Features a built-in microphone



Remote monitoring and recording via multistreaming are available using the IDIS Solution Suite Compact program. For more information on using IDIS Solution Suite Compact, refer to its **operation manual**.



There is a limit to the number of users allowed to connect remotely via the Internet at the same time.

Accessories

Upon purchasing the product, check inside the box to make sure all the following accessories are included. External appearances and colors of the accessories may vary depending on the model.

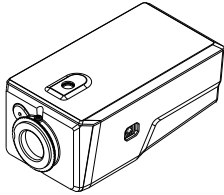

Network Camera

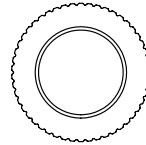

C-Mount Ring



Terminal Block

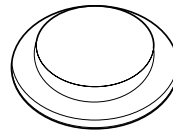

Protective Cover (attaches to camera)

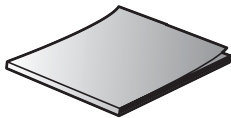

Quick Guide

Overview

Product color and design may vary depending on the model.

Front

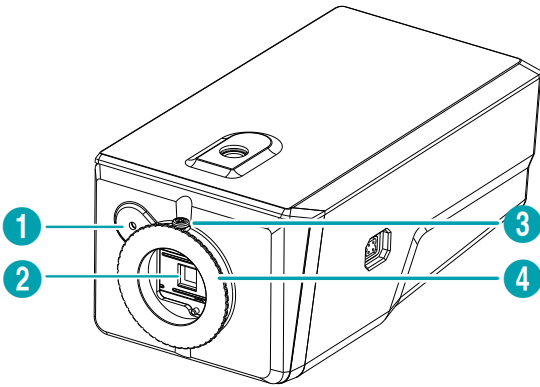

1	Built-in Microphone
2	Image Sensor
3	CS - Mount Ring Screw
4	CS - Mount Ring

- **Built-in Microphone**
Receives audio.
- **Image Sensor**
Converts optical data into electronic signals.
 If the lens is not attached to the camera, use the protective cover to cover up the image sensor.
- **CS-Mount Ring Screw**
Used to secure the mount ring after adjusting the Back Focus.
- **CS-Mount Ring**
Used to tighten the CS mount lens and adjust the Back Focus.

Side

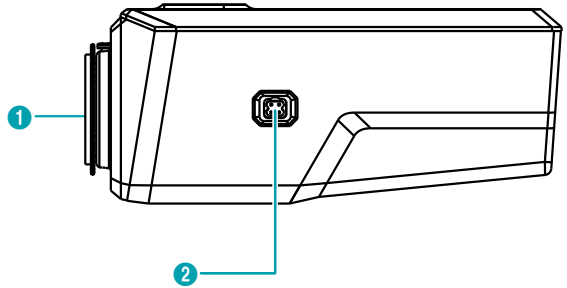

1	Protective Cover
2	Auto Iris Lens Connector

- **Protective Cover**
If the lens is not attached to the camera, use the protective cover to protect the image sensor.
- **Auto Iris Lens Connector**
If using a DC type or P type auto iris lens, connect the auto iris jack.

Top, Bottom

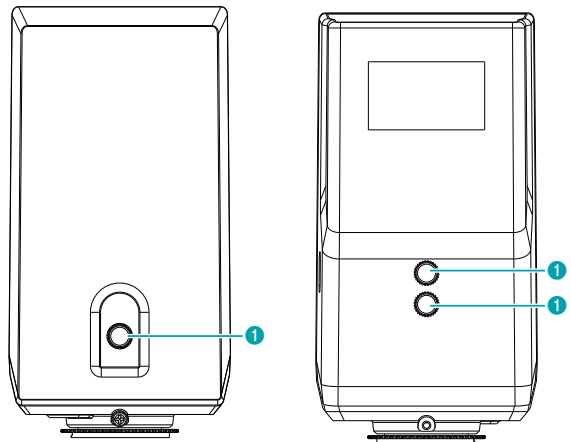

1	Mount Hole (1/4-20 UNC)
---	-------------------------

- **Mount Hole**
This bracket can be installed on either top or bottom of the camera. Use 1/4–20 UNC (20-thread), 2.5mm +/- 0.2mm (ISO standard) or 0.197 (ASA standard) screws to attach the mount.

Back

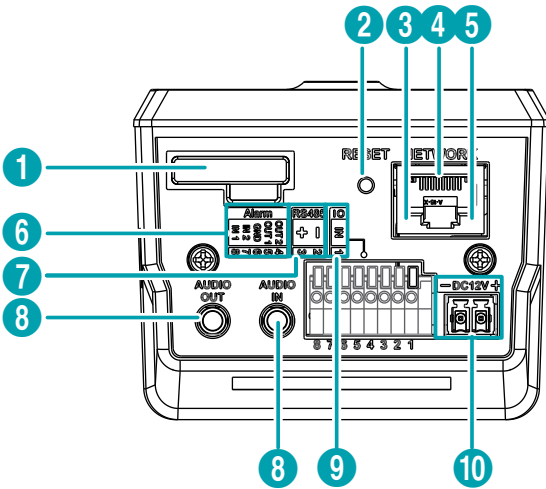

1	SD Memory Card Slot
2	Factory Reset Switch
3	Network LED
4	Network Port
5	Power LED
6	Alarm I/O
7	RS485 Port
8	Audio I/O <i>DC-B4501X model only</i>
9	IO Port
10	Power

• SD Memory Card Slot

Pull on the connection cover and then insert a microSD memory card into the slot. (An SLC (Single Level Cell) or MLC (Multi Level Cell) card by SanDisk or Transcend is recommended)



- Do not remove the SD memory card while the system is in operation. Removing the card while the system is in operation can cause the system to malfunction and/or corrupt data stored on the SD memory card.

- An SD memory card is a consumable product with a finite service life. Prolonged use will damage the card's memory sectors and result in data loss or memory card failure. Test the SD memory card regularly and replace it whenever necessary.

• Factory Reset Switch

Restores the camera's default factory settings. For more information, refer to the **Factory Reset**.

• Network LED

Indicates the network connection status. For more information, refer to the **LED Status Indications**.

• Network Port

Connect a Cat5e cable with an RJ-45 connector to this port. If using a PoE switch, you can supply power to the camera using an ethernet cable. For more information on PoE switch use, refer to the switch manufacturer's operation manual. You can configure, manage, and upgrade this camera and monitor its images from a remote computer over the network. For more information on network connection setup, refer to the **IDIS Discovery operation manual**.

• Power LED

Indicates the system's operating status. For more information, refer to the **LED Status Indications**.

• Alarm I/O

- Out:** It is the BJT (Bipolar Junction Transistor) - open collector output. If the voltage and current exceed the specification limit (Max load: 30mA, Max Voltage: 5VDC), the product could be damaged. When connecting the device which exceeds the specification limit, refer to the picture (circuit) below.

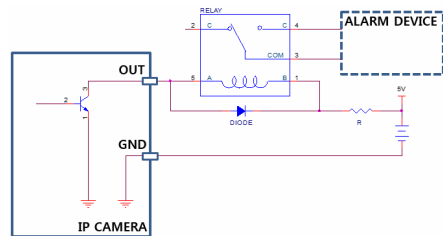

If used with an external inductive load (e.g. relay), a diode must be connected in parallel with the load for protection. Otherwise, the product could be damaged.

- In:** Connect an alarm-in device to this port. (Mechanism: Choose between an NC (Normally Closed) type or an NO (Normally Open) type) Connect a mechanical or electrical switch to the alarm in port and the GND (ground) connector. Alarm in range is 0V to 5V. In order to detect alarm input from an electrical switch, the signal must be higher than 4.3V from an NC switch or less than 0.3V from an NO switch and must last for longer than 0.5 seconds.

• **RS485 Port**

Connect a pan/tilt driver to this port. Connect the driver's TX+/RX+, TX-/RX- to the network camera's +/—-. For more information on RS485 connections, refer to the pan/tilt driver manufacturer's **operation manual**.

• **Audio I/O** *DC-B4501X model only*

- **Out:** Connect an amplifier to this port (line out). This device does not feature a built-in audio amplifier unit and therefore requires the user to purchase a separate speaker system with a built-in amplifier.
- **In:** Connect an audio source (line in). A built-in microphone is featured on the front.

• **IO Port**

This function is not supported.

• **Power**

- **DC12V -/+:** Connect the two wires of the power adapter to these ports. Be careful not to cross the + and - wires. Booting will commence once connected to a power supply.



Fasten the cable to the terminal block provided with the product. Pull on the cable slightly to ensure it is held securely in place. Insert the connected terminal block into the power connector.



- When switching over from 12 VDC to PoE as the power source, the system will be rebooted once the power adapter is disconnected.
- Organize the power cable so that it will not cause people to trip over or become damaged from chairs, cabinets, desks, and other objects in the vicinity. Do not run the power cable underneath carpet or a rug or plug the cable into a power outlet shared by a number of other devices.



When inserting a RS485 connector, hold down the button and push the connector in through the exposed hole. Release the button and then gently pull on the wire to ensure a secure connection. To disconnect the cable, press down on the button again and pull the cable out.



- Check your local laws and regulations on making video or audio recordings. The user will be held liable for any violation of the law.
- The network connector is not designed to be connected directly with cable or wire intended for outdoor use.

Factory Reset

Only use the factory reset switch to restore the camera to its factory default settings.



A factory reset will clear all camera settings configured by the user.

- 1 Shut off the power supply, insert a straight pin into the switch hole, and press down on the reset switch.
- 2 Hold the switch down and reconnect the power adapter.
- 3 Once the device turns back on and its LEDs start blinking, wait 5 seconds and then remove the pin.
- 4 The device will go through the resetting process and reboot. All camera settings will be restored to their factory defaults after the reboot.

It's also possible to do a factory reset by pressing and releasing the reset switch while the camera is turned on or using the IDIS Discovery program from a remote location. A factory reset will reboot the system. For more information on factory reset, refer to the **IDIS Discovery operation manual**.

I/O Connector

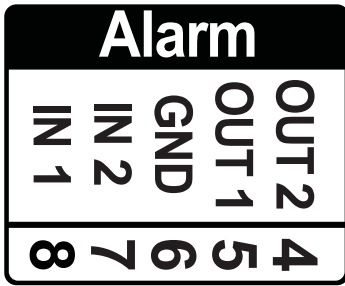

Alarm	In	Alarm In
	GND	Grounding
	Out	Alarm Out (Active Low - Open Collector Output)

RS485 Connector

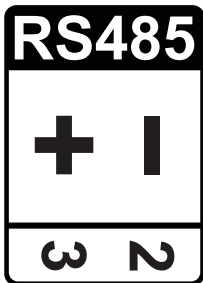

Master Device	Slave Device
+ → To → TX+/ RX+	
- → To → TX-/RX-	

Power Connector

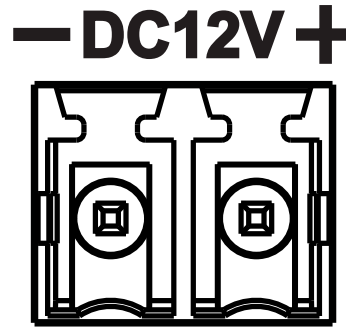

DC12V +	Power connection (Check + and - markings)
DC12V -	

LED Status Indications

LED Status		Description
Power LED	Off	Power not connected
	Flashing	Booting
	On	Powered on
Network LED	On	Not connected to network
Power LED/ Network LED	Flashing (sequentially)	Software upgrade in progress

Installation

The lens must be purchased separately. If you'd like to purchase a lens, contact your camera retailer. This camera supports manual iris lenses, DC type auto iris lenses, and P-iris lenses in either CS-mount or C-mount format.

- Product color and design may vary depending on the model.
- We recommend megapixel lenses for clearer and higher resolution images.
- Video type auto iris lenses are not supported.
- Use a lens that weighs less than 450g. Heavier lenses can cause the camera to lose its balance.
- Change the setting of iris mode when installing P-iris lenses.



- Check the wall or ceiling to see if it needs to be reinforced. The camera may fall off if the wall or ceiling is not strong enough to support its weight.
- Install the camera in a shaded area. If the camera is installed in direct sunlight, it may be affected adversely.

- 2 Remove the protective cover from the camera.
- 3 Turn the lens in clockwise direction, mount it on to the camera, and connect the auto iris jack to the auto iris lens connector.



If the length of the auto iris jack is long, wind it around the lens properly.

Manual Iris Lens

- 1 Remove the protective cover from the camera.
- 2 Turn the lens in clockwise direction and mount it on the camera.
- 3 Rotate the lens' iris ring to open up the iris and then adjust accordingly.

DC Type/P Type Auto Iris Lens

- 1 Solder on the lens connection line to the connector socket, if necessary. For more information about soldering on the lens control wire, refer to the lens manufacturer's **operation manual**.

CS-Mount Lens

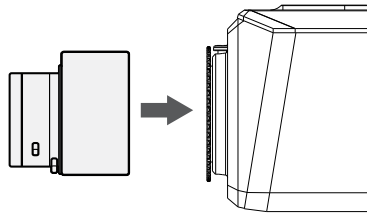

- 1 Remove the protective cover from the camera.
- 2 Turn the lens in clockwise direction and mount it on the camera.

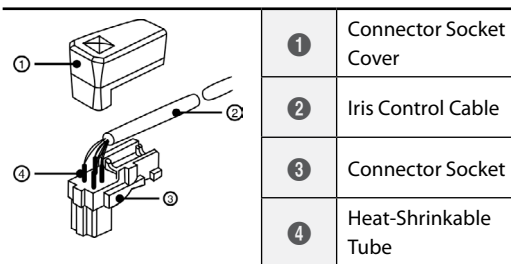

	PIN	Name (DC)	Name (P)
①		Brake (Damp) Coil -	B+
②		Drive Coil +	A+
③		Brake (Damp) Coil +	A-
④		Drive Coil -	B-

C-Mount Lens

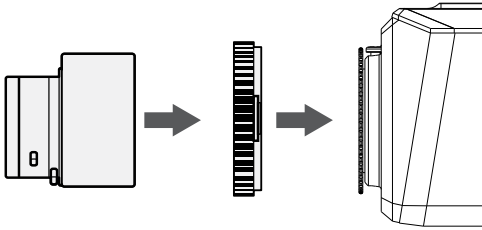

- 1 Remove the protective cover from the camera.
- 2 Turn the mount ring in clockwise direction and mount the ring on to the camera.
- 3 Turn the C-mount lens in clockwise direction and mount it on to the C-mount ring.

Side

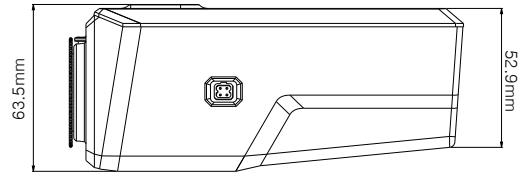

Dimensions

top

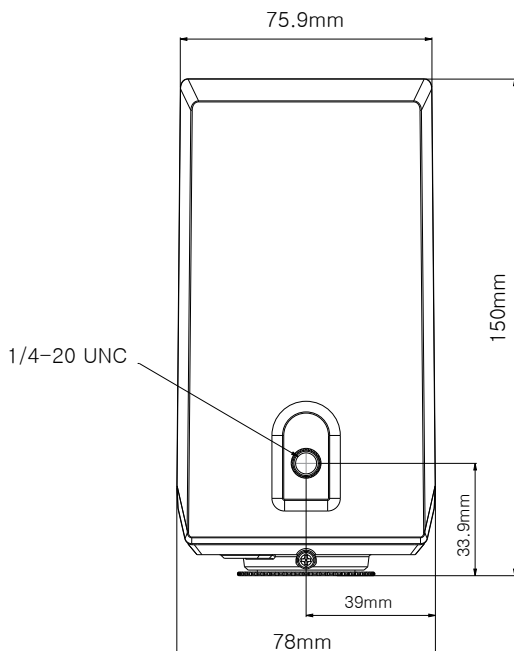

Part 2 - Camera Connection

Use the camera by connecting to DirectIP™ NVR or non DirectIP™ NVR, VMS such as IDIS Solution Suite Compact.

With DirectIP™ NVR-based Layout

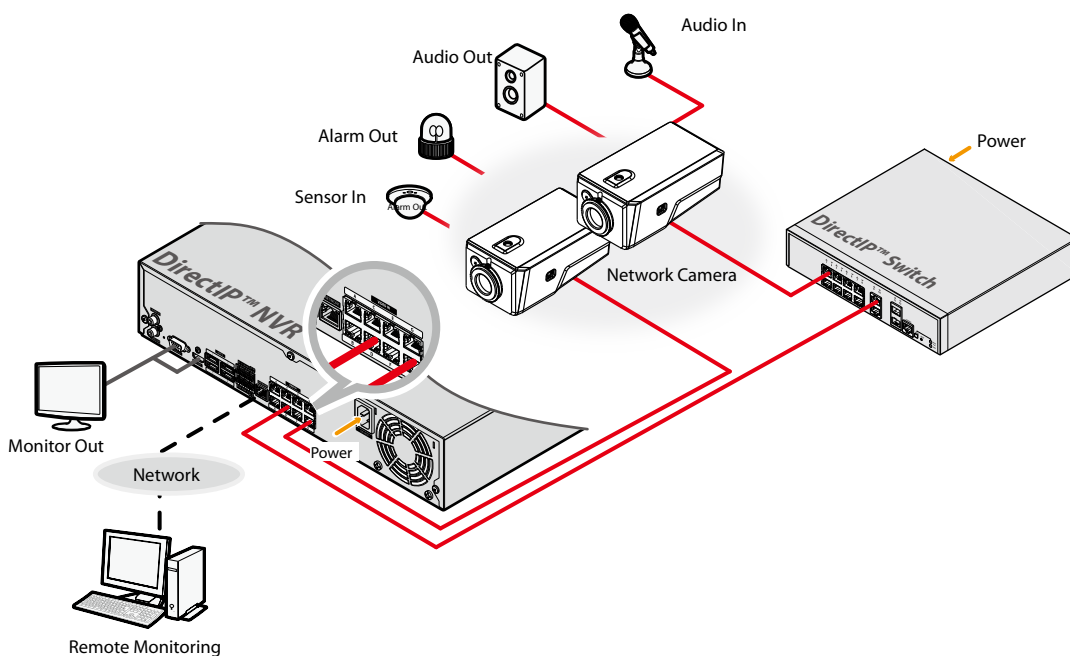

DirectIP™ NVR makes it easy to use cameras without extra network configurations. Each camera can be controlled via the DirectIP™ NVR setup menu, without any PC. For detailed camera settings, please see the camera setting pages of DirectIP™ NVR manual.

For users using the camera with DirectIP™ NVR connection, do not need to consider contents in the camera operation manual.

With non DirectIP™ NVR-based Layout

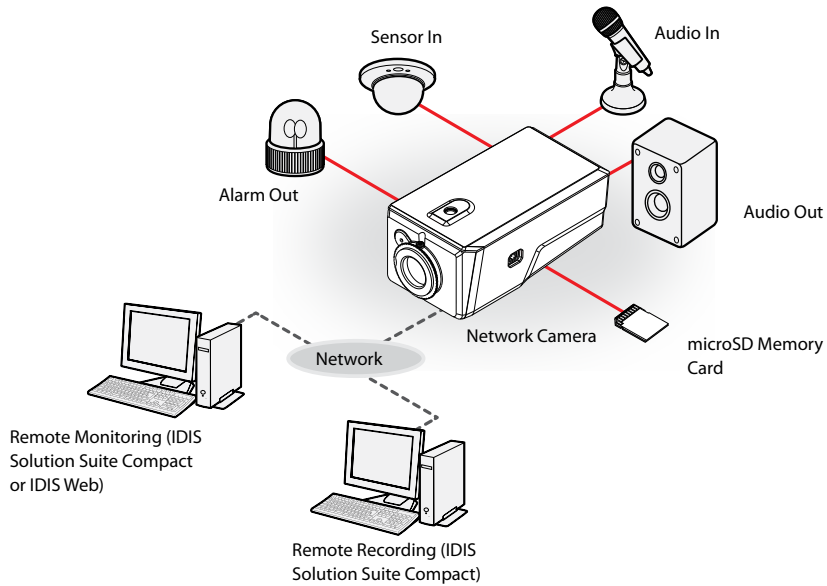

Control the camera over the network from software installed on a computer.
Ideal for using the camera over the network from a remote location.

The contents in the camera operation manual are only for users using the camera with non DirectIP™ NVR connection or VMS connection such as IDIS Solution Suite Compact.

Part 3 - Appendix

Troubleshooting

Problem	Check
The main unit won't turn on.	<ul style="list-style-type: none">• Check the power cable connection.• Check the power outlet.
PoE switch isn't being recognized.	Check the grounding status of the I/O device connected to the camera and the PoE switch. If they are not grounded, ground them and try again.
I can't see Live videos.	<ul style="list-style-type: none">• Check the camera's power status.• Check the network connection status of the computer and the network camera.
Images are blurry.	<ul style="list-style-type: none">• Make sure the lens is clean. If not, clean it using a soft piece of cloth or a brush.• Make sure the lens is in focus. Adjust the focus during daytime.• If there is too much light coming into the camera or the camera is picking up an overly bright light source, adjust the camera's position/angle accordingly.
Video color appears incorrect.	Check the white balance settings. If using the Auto option, it may take some time for the white balance to be adjusted.
Images are blinking.	If the camera is pointed at the sun or a fluorescent lamp, adjust the camera's angle away.
Lost the admin ID and password and unable to connect to a network camera.	You must perform a factory reset. A factory reset will revert all settings, including network settings, to their factory defaults. After performing a factory reset, make a memo of the admin ID and password as a safety precaution.
Unable to launch IDIS Web.	If the IDIS Web login screen is not loading, check which version of Microsoft Internet Explorer you are using. IDIS Web may not launch properly on versions 8.0 or below.

Specifications



These product specifications may change without prior notice.

Video

Image Sensor	1/2.8" CMOS
Max. Resolution	2592 x 1944
Scanning Mode	Progressive Scan
Lens type	Optional (CS/C-Mount)
Iris Control	P-Iris, Manual iris, DC type auto iris (megapixel recommended)
Min. Illumination	COLOR : 0.15 lux @ F1.2 B&W : 0.015 lux @ F1.2
Dynamic Range	120dB, True WDR
Electronic Shutter Speed	Auto / Manual (1/30 ~ 1/10,000), Anti-Flicker, Slow Shutter(1 ~ 1/5, 1/7.5, 1/15)
Day & Night	IR cut filter with auto switch

Network

Video Compression	H.265, H.264(MP), M-JPEG
Bitrate Control	CBR / VBR
Max. Frame Rate	30ips: 2592x1944
Audio Compression <i>DC-B4501X model only</i>	G.726, G.711 u-Law, G.711 a-Law, ADPCM
Supported Resolution	4:3 : 2592x1944, 1920x1440, 1280x960x 640x480 16:9 : 2592x1456, 1920x1080, 1280x720, 640x360
Multi-Video Streaming	Quadruple
Ethernet	RJ45(10/100BASE-T)
Edge Storage* (Optional)	 (micro SD/SDHC/SDXC memory card (class 6 or higher, max. 256GB))

* An SLC (Single Level Cell) or MLC (Multi Level Cell) card by SanDisk or Transcend is recommended to ensure stable recording performance.

* An SD memory card is a consumable product with a finite service life. Prolonged use will damage the card's memory sectors and result in data loss or memory card failure. Test the SD memory card regularly and replace it whenever necessary.

* microSD Logo is a trademark of SD-3C, LLC.

I/O

Audio In	<i>DC-B4501X model</i>	Line-in 1ea / Internal Mic 1ea
Audio Out	<i>only</i>	Line-out 1ea
Alarm In		2 TTL, NC/NO Programmable, 4.3V(NC) or 0.3V(NO) threshold, 5V DC
Alarm Out		2 TTL open collectors, Max. load: 30mA, Max. voltage: 5VDC
Auto Iris Out		4-pin mini din jack (standard connection)

General

Operating Temperature	-10°C ~ +50°C (+14°F ~ +122°F)
Boot Up Temperature	0°C ~ +50°C (+32°F ~ +122°F)
Operating Humidity	0% ~ 90%
Power Source	12V $\overline{\text{---}}$, PoE
Power Consumption	12V $\overline{\text{---}}$, 0.5A, 6W PoE, IEEE 802.3af(Class 2), 5.6W
Approval	FCC, CE
External Dimensions (W x H x D)	78mm x 63.5mm x 150mm (3.07" x 2.5" x 5.9")
Weight (Main Unit)	0.3kg (0.66lb)



IDIS Co., Ltd.

For more information, please visit at
www.idisglobal.com