



Network Video Recorder

Installation Manual

DR-6216P-S

DR-6232P-S



Powered by ***Direct IP™***

Before reading this manual

This manual contains basic instructions on installing and using DirectIP™ Network Video Recorder, an IDIS product. Users who are using this product for the first time, as well as users with experience using comparable products, must read this manual carefully before use and heed to the warnings and precautions contained herein while using the product. Safety warnings and precautions contained in this manual are intended to promote proper use of the product and thereby prevent accidents and property damage and must be followed at all times. Once you have read this manual, keep it at an easily accessible location for future reference.

- 
 • The manufacturer will not be held responsible for any product damage resulting from the use of unauthorized parts and accessories or from the user's failure to comply with the instructions contained in this manual.
- It is recommended that first-time users of DirectIP™ Network Video Recorder and individuals who are not familiar with its use seek technical assistance from their retailer regarding product installation and use.
- If you need to disassemble the product for functionality expansion or repair purposes, you must contact your retailer and seek professional assistance.
- Both retailers and users should be aware that this product has been certified as being electromagnetically compatible for commercial use. If you have sold or purchased this product unintentionally, please replace with a consumer version.

Safety Precautions

| | | |
|---|----------------|---|
|  | CAUTION |  |
| RISK OF ELECTRIC SHOCK DO NOT OPEN | | |
| CAUTION: TO REDUCE THE RISK OF ELECTRIC SHOCK, DO NOT REMOVE COVER (OR BACK). NO USER-SERVICEABLE PARTS INSIDE. REFER SERVICING TO QUALIFIED SERVICE PERSONNEL. | | |



The lightning flash with arrowhead symbol, within an equilateral triangle, is intended to alert the user to the presence of uninsulated "dangerous voltage" within the product's enclosure that may be of sufficient magnitude to constitute a risk of electric shock.



The exclamation point within an equilateral triangle is intended to alert the user to the presence of important operating and maintenance (servicing) instructions in the literature accompanying the appliance.

| Symbol | Publication | Description |
|---|--------------------------|---------------------|
|  | IEC60417, No.5032 | Alternating current |

Important Safeguards

1. Read Instructions

All the safety and operating instructions should be read before the appliance is operated.

2. Retain Instructions

The safety and operating instructions should be retained for future reference.

3. Cleaning

Unplug this equipment from the wall outlet before cleaning it. Do not use liquid aerosol cleaners. Use a damp soft cloth for cleaning.

4. Attachments

Never add any attachments and/or equipment without the approval of the manufacturer as such additions may result in the risk of fire, electric shock or other personal injury.

5. Water and/or Moisture

Do not use this equipment near water or in contact with water.

6. Ventilation

Place this equipment only in an upright position. This equipment has an open-frame Switching Mode Power Supply (SMPS), which can cause a fire or electric shock if anything is inserted through the ventilation holes on the side of the equipment.

7. Accessories

Do not place this equipment on an unstable cart, stand or table. The equipment may fall, causing serious injury to a child or adult, and serious damage to the equipment. Wall or shelf mounting should follow the manufacturer's instructions, and should use a mounting kit approved by the manufacturer.



This equipment and cart combination should be moved with care. Quick stops, excessive force, and uneven surfaces may cause the equipment and cart combination to overturn.

8. Power Sources

This equipment should be operated only from the type of power source indicated on the marking label. If you are not sure of the type of power, please consult your equipment dealer or local power company. You may want to install a UPS (Uninterruptible Power Supply) system for safe operation in order to prevent damage caused by an unexpected power stoppage. Any questions concerning UPS, consult your UPS retailer.

This equipment should be remain readily operable.

9. Power Cords

Operator or installer must remove power and TNT connections before handling the equipment.

10. Lightning

For added protection for this equipment during a lightning storm, or when it is left unattended and unused for long periods of time, unplug it from the wall outlet and disconnect the antenna or cable system. This will prevent damage to the equipment due to lightning and power-line surges.

11. Overloading

Do not overload wall outlets and extension cords as this can result in the risk of fire or electric shock.

12. Objects and Liquids

Never push objects of any kind through openings of this equipment as they may touch dangerous voltage points or short out parts that could result in a fire or electric shock. Never spill liquid of any kind on the equipment.

13. Servicing

Do not attempt to service this equipment yourself. Refer all servicing to qualified service personnel.

14. Damage requiring Service

Unplug this equipment from the wall outlet and refer servicing to qualified service personnel under the following conditions:

A. When the power-supply cord or the plug has been damaged.

B. If liquid is spilled, or objects have fallen into the equipment.

C. If the equipment has been exposed to rain or water.

D. If the equipment does not operate normally by following the operating instructions, adjust only those controls that are covered by the operating instructions as an improper adjustment of other controls may result in damage and will often require extensive work by a qualified technician to restore the equipment to its normal operation.

E. If the equipment has been dropped, or the cabinet damaged.

F. When the equipment exhibits a distinct change in performance this indicates a need for service.

15. Replacement Parts

When replacement parts are required, be sure the service technician has used replacement parts specified by the manufacturer or that have the same characteristics as the original part. Unauthorized substitutions may result in fire, electric shock or other hazards.

16. Safety Check

Upon completion of any service or repairs to this equipment, ask the service technician to perform safety checks to determine that the equipment is in proper operating condition.

17. Field Installation

This installation should be made by a qualified service person and should conform to all local codes.

18. Correct Batteries

Warning: Risk of explosion if battery is replaced by an incorrect type. This equipment should be remain readily operable. Dispose of used batteries according to the instructions. The battery shall not be exposed to excessive heat such as sunshine, fire or the like.

19. Tmra

A manufacturer's maximum recommended ambient temperature (Tmra) for the equipment must be specified so that the customer and installer may determine a suitable maximum operating environment for the equipment.

20. Elevated Operating Ambient Temperature

If installed in a closed or multi-unit rack assembly, the operating ambient temperature of the rack environment may be greater than room ambient. Therefore, consideration should be given to installing the equipment in an environment compatible with the manufacturer's maximum rated ambient temperature (Tmra).

21. Reduced Air Flow

Installation of the equipment in the rack should be such that the amount of airflow required for safe operation of the equipment is not compromised.

22. Mechanical Loading

Mounting of the equipment in the rack should be such that a hazardous condition is not caused by uneven mechanical loading.

23. Circuit Overloading

Consideration should be given to connection of the equipment to supply circuit and the effect that overloading of circuits might have on over current protection and supply wiring. Appropriate consideration of equipment nameplate ratings should be used when addressing this concern.



24. Reliable Earthing (Grounding)

Reliable grounding of rack mounted equipment should be maintained. Particular attention should be given to supply connections other than direct connections to the branch circuit (e.g., use of power strips).

HDMI Port Precautions

- Use a certified cable marked with an HDMI logo when using an HDMI. The screen may not appear or a connection error may occur if you do not use a certified HDMI cable.
- It is recommended that you use the following HDMI cable type.
 - High-speed HDMI Cable
 - High-speed HDMI Cable with Ethernet

In-Text

| Symbol | Type | Description |
|---|----------------|---|
|  | Caution | Important information concerning a specific function. |
|  | Note | Useful information concerning a specific function. |

User's Caution Statement

Caution: Any changes or modifications to the equipment not expressly approved by the party responsible for compliance could void your authority to operate the equipment.

FCC Compliance Statement

THIS EQUIPMENT HAS BEEN TESTED AND FOUND TO COMPLY WITH THE LIMITS FOR A CLASS A DIGITAL DEVICE, PURSUANT TO PART 15 OF THE FCC RULES. THESE LIMITS ARE DESIGNED TO PROVIDE REASONABLE PROTECTION AGAINST HARMFUL INTERFERENCE WHEN THE EQUIPMENT IS OPERATED IN A COMMERCIAL ENVIRONMENT. THIS EQUIPMENT GENERATES, USES, AND CAN RADIATE RADIO FREQUENCY ENERGY AND IF NOT INSTALLED AND USED IN ACCORDANCE WITH THE INSTRUCTION MANUAL, MAY CAUSE HARMFUL INTERFERENCE TO RADIO COMMUNICATIONS. OPERATION OF THIS EQUIPMENT IN A RESIDENTIAL AREA IS LIKELY TO CAUSE HARMFUL INTERFERENCE, IN WHICH CASE USERS WILL BE REQUIRED TO CORRECT THE INTERFERENCE AT THEIR OWN EXPENSE.

WARNING: CHANGES OR MODIFICATIONS NOT EXPRESSLY APPROVED BY THE PARTY RESPONSIBLE FOR COMPLIANCE COULD VOID THE USER'S AUTHORITY TO OPERATE THE EQUIPMENT.

THIS CLASS OF DIGITAL APPARATUS MEETS ALL REQUIREMENTS OF THE CANADIAN INTERFERENCE CAUSING EQUIPMENT REGULATIONS.

WEEE (Waste Electrical & Electronic Equipment)

Correct Disposal of This Product

(Applicable in the European Union and other European countries with separate collection systems)



This marking shown on the product or its literature, indicates that it should not be disposed with other household wastes at the end of its working life. To prevent possible harm to the environment or human health from uncontrolled waste disposal, please separate this from other types of wastes and recycle it responsibly to promote the sustainable reuse of material resources.

Household users should contact either the retailer where they purchased this product, or their local government office, for details of where and how they can take this item for environmentally safe recycling.

Business users should contact their supplier and check the terms and conditions of the purchase contract. This product should not be mixed with other commercial wastes for disposal.

Copyright

© 2016 IDIS Co., Ltd.

IDIS Co., Ltd. reserves all rights concerning this manual.

Use or duplication of this manual in part or whole without the prior consent of IDIS Co., Ltd. is strictly prohibited.

Contents of this manual are subject to change without prior notice.

Registered Trademarks

IDIS is a registered trademark of IDIS Co., Ltd.

Other company and product names are registered trademarks of their respective owners.

The information in this manual is believed to be accurate as of the date of publication even though explanations of some functions may not be included. We are not responsible for any problems resulting from the use thereof. The information contained herein is subject to change without notice. Revisions or new editions to this publication may be issued to incorporate such changes.

The software included in this product contains some Open Sources. You may obtain the complete corresponding source code from us. See the Open Source Guide on the software CD (OpenSourceGuide\OpenSourceGuide.pdf) or as a printed document included along with the Manual.

Table of Contents

1

Part 1 – Introduction..... 7

- Product Features7
- Accessories.....9
- Overview10
 - Front Panel.....10
 - Rear Panel13
 - Rear Panel Connections14
 - Remote Control18

2

Part 2 - Appendix.....21

- System Log Types21
- Error Code Types22
- Troubleshooting25
- Specifications26

Part 1 – Introduction

Product Features

This is a DirectIP™-enabled video recorder that supports surveillance, recording, and playback of video from network cameras (or video encoders).

This NVR (Network Video Recorder) unit offers the following features:

- Real-time 16/32-channel DirectIP™ network surveillance
- Network camera zero configuration
- Configuration-free network camera access
- Supports up to Full HD 960ips video recording (DR-6232P-S)
- HDMI out (1) and VGA out (1) ports
- Fast and easy search feature (Time-Lapse, Event log, Thumbnail, Motion, Text-In)
- Simultaneously survey, record, play back, and transmit data in real-time
- Graphic User Interface(GUI) and multilingual
- Multiple recording modes (Schedule, Event, Pre-Event, and Panic)
- PoE-enabled Camera Connection
- Two USB 2.0 ports (for connecting peripherals, upgrading software, and saving recording data)
- 6 internal SATA2 HDD bays and 4 eSATA ports
- Two-way audio communication
- Network camera audio recording and 1-channel audio playback
- 4 alarm ins, 1 alarm out, and 1 alarm reset
- IR remote control-enabled
- Self-diagnosis and automated system event alerts (industry standard S.M.A.R.T. protocol for HDD status alerts)
- Records the same data on the two disks at the same time

Part 1 – Introduction





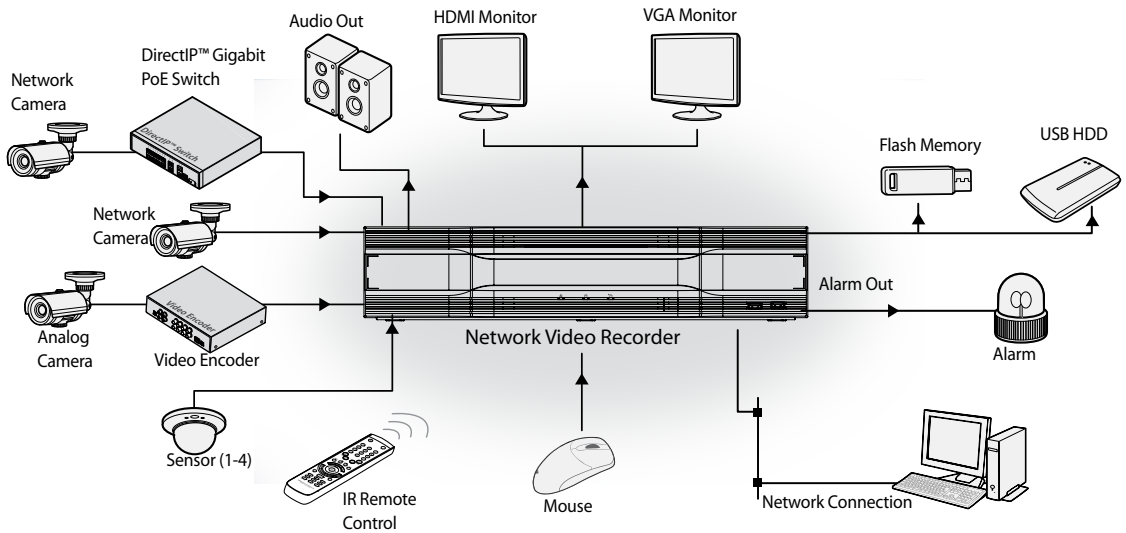

This document covers the 16- and 32-channel network video recorders. The NVRs are identical except for the number of cameras and alarms that can be connected and the number of cameras that can be displayed. For simplicity, the illustrations and descriptions in this document refer to the 32-channel model.

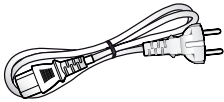
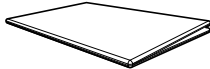

Accessories

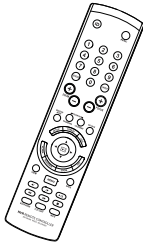
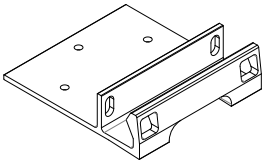
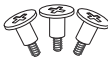
Upon unpackaging the product, check the contents inside to ensure that all the following accessories are included.

| | | |
|---|---|--|
|  |  |  |
| Network Video Recorder | Power Cable | Quick Guide |
|  |  |  |
| Manual and IDIS Center Program CD | Optical USB Mouse | IR Remote Control |
|  |  |  |
| Rack-mount Kit | Assembly Screws for Adding Hard Disk Drives | SATA2 cables |

Overview

Front Panel

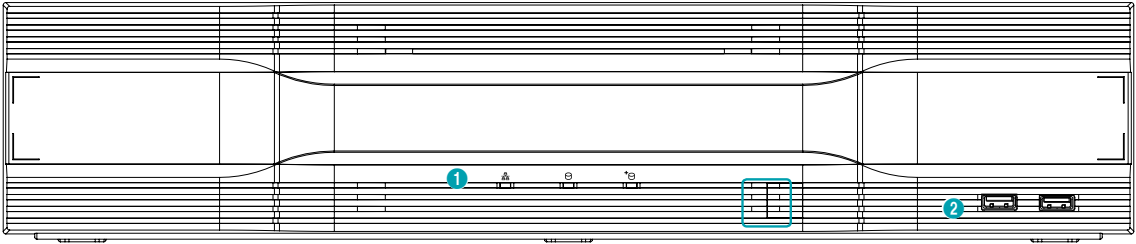



| | | | |
|---|------|---|-----------|
| ① | LEDs | ② | USB Ports |
|---|------|---|-----------|



- Remote control sensor is located on the right side of the front panel. Ensure that the sensor remains unobstructed at all times. If obstructed, the sensor might not be able to receive remote control signals.
- Placing a Wi-Fi, Bluetooth, or any other wireless communication device near the NVR may interfere with remote control signal transmission.
- Access various windows and menus using a USB mouse as you would on a personal computer.
- For easier system configuration, a USB mouse is recommended.

① LEDs

-  **Network LED:** Flashes when the main unit is linked to an ethernet.
-  **HDD LED:** Flashes when data is being written on the HDD or a video search is in progress.
-  **eSATA LED:** Lights up when the main unit is connected to an eSATA device.

② USB Ports

• Storage Device Connection

Connect an external USB hard drive or a USB flash memory device to one of the USB ports for use with the Clip Copy feature. The external storage device should be placed as close to the NVR as possible. It is recommended that you use a connection cable that is no longer than 180cm in length. Use the connection cable included with your external storage device to connect the device to one of NVR's USB ports. For more information Clip Copy, refer to the **Clip Copy in the operation manual**.

• Peripheral Device Connection

Use the USB ports to connect peripherals such as a USB mouse to the NVR. You can also use a USB-to-serial converter and connect multiple text-in devices to the NVR at the same time.



For USB flash memory devices, the NVR supports the FAT32 file format only.

Connections on the Front Panel

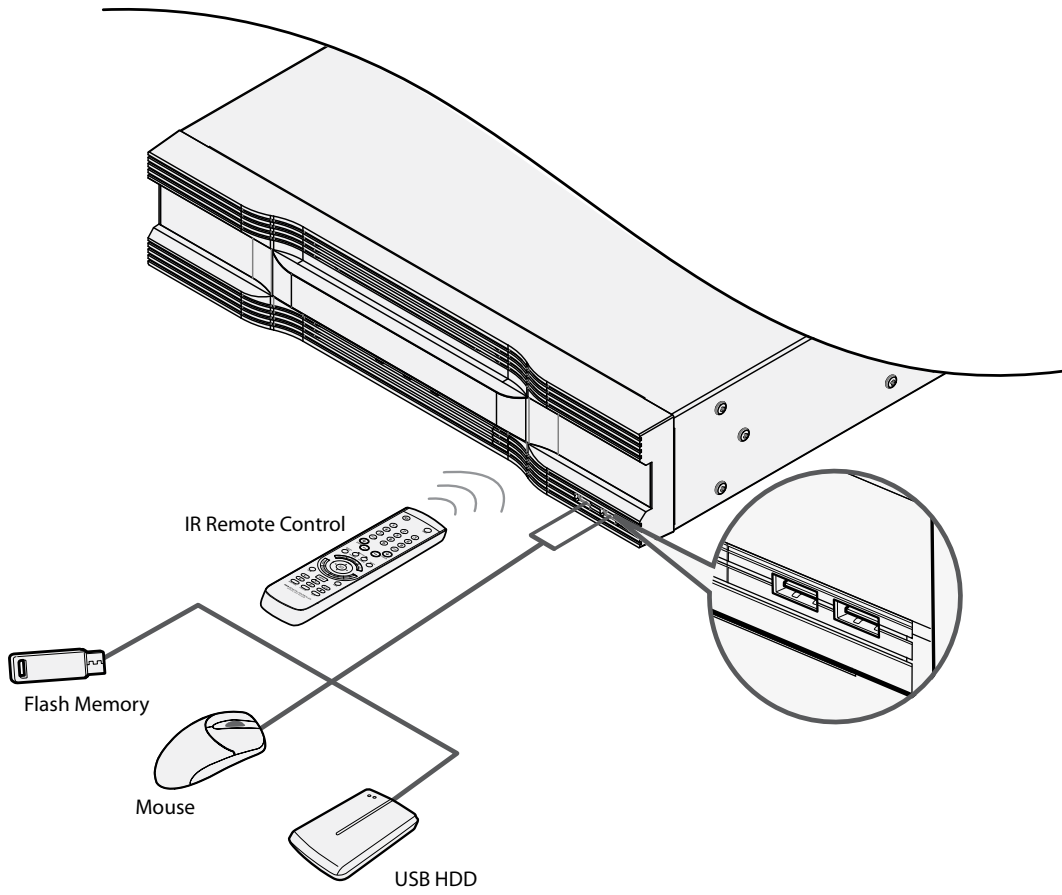

Rear Panel

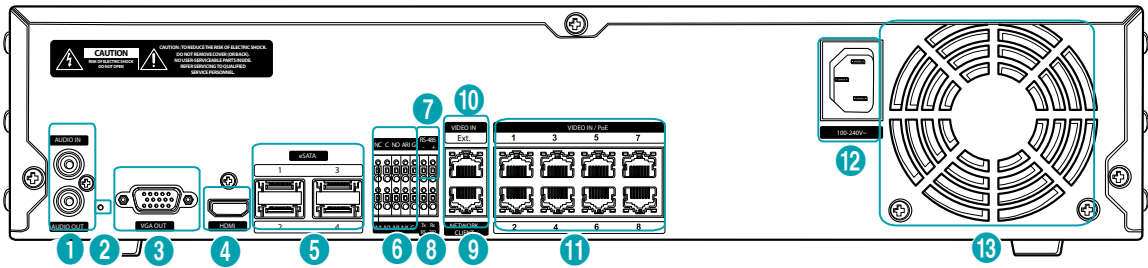

| | | | | | |
|----|----------------------|----|----------------------|----|------------------------|
| 1 | Audio Ports | 2 | Factory Reset Button | 3 | VGA Out Port |
| 4 | HDMI Out Port | 5 | eSATA Ports | 6 | Alarm Connection Ports |
| 7 | RS-485 Port | 8 | RS-232 Port | 9 | Network Port |
| 10 | Video In / Ext. Port | 11 | Video In / PoE Ports | 12 | Power In Port |
| 13 | Vent | | | | |

Rear Panel Connections

Monitor Connection

Connect to the **VGA OUT** or **HDMI** port.

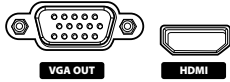

- ✓ Use a certified cable marked with an HDMI logo when using an HDMI. The screen may not appear or a connection error may occur if you do not use a certified HDMI cable.
- It is recommended that you use the following HDMI cable type.
 - High-speed HDMI Cable
 - High-speed HDMI Cable with Ethernet

Audio Connection

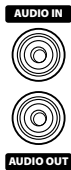

Connect the audio device to the **AUDIO IN** port and speakers with a built-in amplifier to the **AUDIO OUT** port. Use the **AUDIO OUT** port to listen to audio from network cameras.

Use the **AUDIO IN** port to establish two-way communication with cameras.

- ✓ This NVR does not feature a built-in audio amplifier unit and therefore requires the user to purchase a speaker system with a built-in amplifier separately. It's possible to connect an amplified audio source to the NVR, but microphones that do not have a built-in amplifier will not function properly if connected to the NVR directly. If this is the case, connect the microphone to the NVR via a pre-amp.
- Check your local laws and regulations on making audio recordings.

Video Connection

• Video In/PoE Port

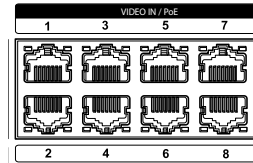

Connect network cameras or video encoders to the NVR using RJ-45 cable (Cat5, Cat5e, or Cat6). In addition to cameras or video encoders, you can connect external hubs (Optional: DH-2112PF, DH-2128PF) to form a network. The NVR recognizes DirectIP™ network cameras automatically. Ports A through H support PoE.

- ✓ We recommend that you use the Ext. port for connecting to an external hub and using features such as camera alignment.
- Green LED on the right will turn on when PoE comes on line. Orange LED on the left will then flash once a link has been established.
- If more than 16 cameras from video encoders are registered on the NVR, video may not be displayed smoothly in a remote program.

• Video In / Ext. Port



This port does not support PoE. It's possible to establish a network with network cameras and external hubs using a Cat6 cable.

- ✓ Green LED on the right will turn on if connected to a 1000 BASE-T network. Orange LED on the left will then flash once a link has been established.
- When using a Cat5e cable, the data transfer speed may decrease depending on how to establish a network.

Network Connection



This NVR is capable of connecting to networks via an ethernet connector. Connect an RJ-45 cable (Cat5, Cat5e, or Cat6) to the NVR's network port. It's possible to operate and upgrade the NVR remotely over a network. For more information on ethernet connection setup, refer to **Network Setup in the operation manual**.



- Connector directions may vary depending on the NVR model.
- Green LED on the right will begin to flash if connected a 1000 BASE-T network. Orange LED on the left will then flash once a link has been established.

eSATA Connection

Connect external hard drives to these ports.

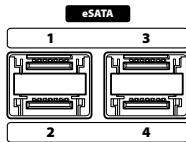

Do not connect or disconnect an eSATA device while the NVR is powered on. To connect an eSATA device, first turn off the NVR and unplug the power cable. Connect the eSATA device and then power the eSATA device first and then NVR back on. To disconnect an eSATA device, first turn off the NVR and unplug the power cable. Turn off the eSATA device and then disconnect the eSATA connection cable.

RS-232 Connection

Connect an external device such as a POS unit to this port.



RS-485 Connection

This NVR supports the RS-485 half-duplex serial communication protocol for connecting to external devices such as POS units.



Alarm Connection

Connect alarm connectors to these ports.

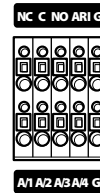

Press down on the button and insert the cable into the opening. Release the button and then pull on the cable slightly to ensure it is held securely in place. To disconnect the cable, press down on the button again and pull the cable out.

● **Alarm In 1 through 4**

This NVR is capable of responding to event signals from external alarm in devices. Connect mechanical or electrical switches to AI 1 through 4 and the G (ground) connector. In order to be recognized by the NVR, the signal from an alarm in device must be less than 0.3V (Normally Open) and maintained for at least 0.5 seconds. The alarm in voltage range is 0V to 5V. For more information on alarm in setup, refer to the **Alarm-In in the operation manual.**

● **G (Ground)**

Connect alarm in or out's ground cable to the G connector.

All connectors marked "G" are common connectors.

● **NC/NO (Relay Alarm Outputs)**

This NVR is capable of activating/deactivating buzzers, lights, and other external devices. Connect the device to the C (Common) and NC (Normally Closed) or C and NO (Normally Open) connectors. NC/NO is a relay output which sinks 2A@125VAC and 1A@30VDC. For more information on alarm out setup, refer to the **Alarm-Out in the operation manual.**

● **ARI (Alarm Reset In)**

An external signal to the Alarm Reset In can be used to reset both the Alarm Out signal and the NVR's internal buzzer. Mechanical or electrical switches can be wired to the ARI (Alarm Reset In) and GND (Ground) connectors. The threshold voltage is below 0.3V and should be stable at least 0.5 seconds to be detected. Connect the wires to the ARI and GND connectors.

● **Connector Arrangement**

| | |
|------------------------|--|
| AI1 through AI4 | Alarm In 1 through 4 |
| G | Ground |
| C | Relay Common |
| NO/NC | Normally Open and Normally Close Relay Alarm Out (connected to C port) |

Power Cable Connection

Connect the power cable to this port. This NVR does not feature a separate power on/off button and will turn on the moment power is supplied.

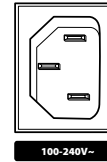

- Organize the power cable so that it will not cause people to trip over or become damaged from chairs, cabinets, desks, and other objects in the vicinity. Do not run the power cable underneath a rug or carpet.
- The power cable is grounded. Do not modify the power plug even if your power outlet does not have a ground contact.
- Do not connect multiple devices to a single power outlet.

Factory Reset



Located right next to the Audio Out port on the rear of the NVR is a switch that, once activated, will reset the NVR to all its initial factory settings.

- A factory reset will clear all NVR settings configured by the user.
- You will need a straightened paper clip to access the factory reset button.

- 1 Turn off the NVR.
- 2 Insert a straightened paper clip into the factory reset switch hole and press the switch. Turn on the NVR while holding the switch.
- 3 Press and hold until you hear 2 beeps from the NVR's internal buzzer.
- 4 All NVR settings will be returned to their factory values once you remove the paper clip.

Connections on the Rear Panel

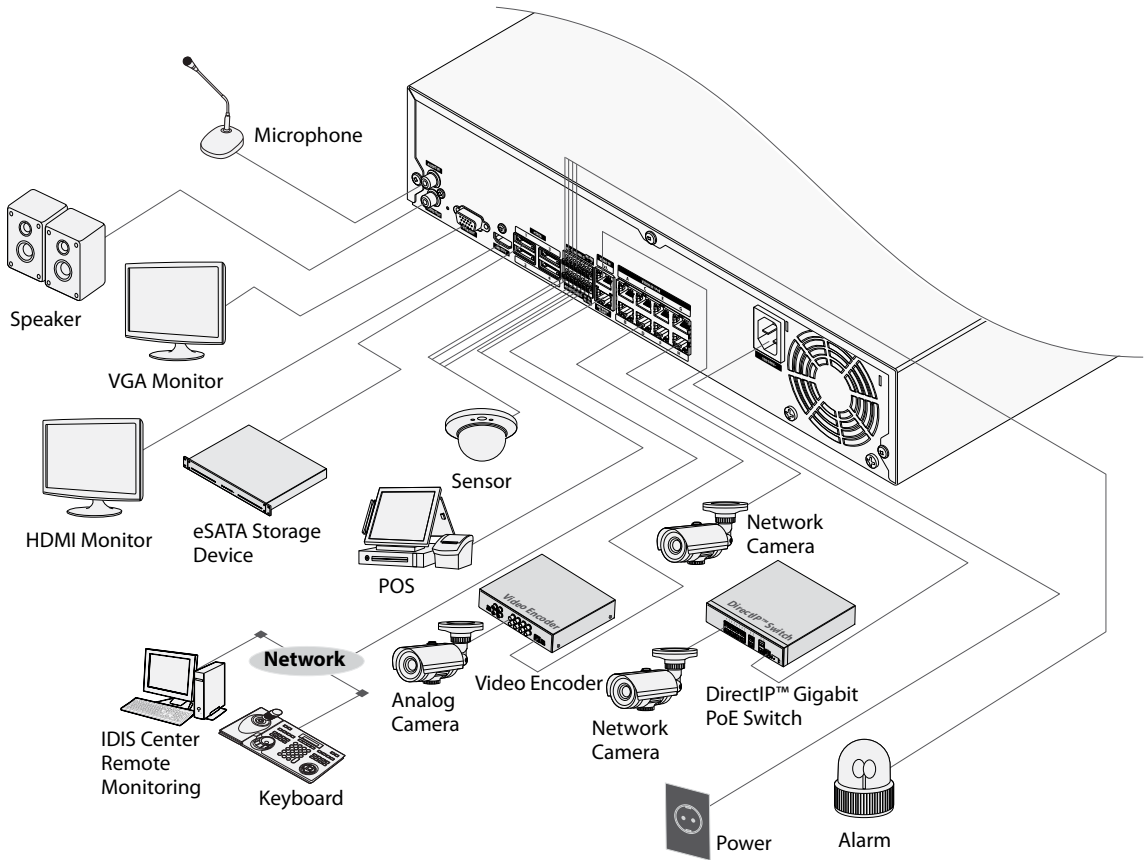

Remote Control

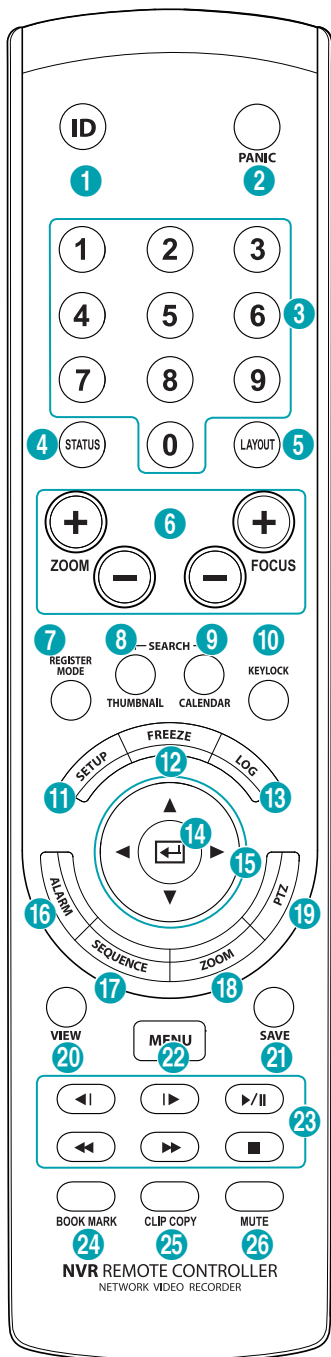

| | |
|----|----------------------|
| 1 | ID Button |
| 2 | PANIC Button |
| 3 | Camera Buttons |
| 4 | STATUS Button |
| 5 | LAYOUT Button |
| 6 | PTZ Control Buttons |
| 7 | REGISTER MODE Button |
| 8 | THUMBNAIL Button |
| 9 | CALENDAR Button |
| 10 | KEYLOCK Button |
| 11 | SETUP Button |
| 12 | FREEZE Button |
| 13 | LOG Button |
| 14 | Enter Button |
| 15 | Arrow Buttons |
| 16 | ALARM Button |
| 17 | SEQUENCE Button |
| 18 | ZOOM Button |
| 19 | PTZ Button |
| 20 | VIEW Button |
| 21 | SAVE Button |
| 22 | MENU Button |
| 23 | Playback Buttons |
| 24 | BOOKMARK Button |
| 25 | CLIP COPY Button |
| 26 | MUTE Button |

① ID Button

Used to assign remote control ID values.

No additional remote control assignment is necessary if the system's ID is 0. If the system's ID is a number between 1 and 99, however, you will need to press the ID button and then press the system ID number on the remote control. If the system's ID is set in double digits, press each digit button consecutively. The  (remote control) icon will appear on the upper right corner of the NVR screen (status indication area) to indicate successful system-to-remote control pairing. If using multiple systems, it's possible to control all the units with a single remote control as long as all the system IDs are 0. For more information on system IDs, refer to the **System Setup in the operation manual**.

② PANIC Button

Pressing this button displays the  icon and commences recording irrespective of the current schedule.

Press the button again to deactivate Panic Recording mode.

③ Camera Buttons

Pressing the **Camera** button while in Live or Playback mode displays images from the selected camera in full screen. To select a camera whose channel is made up of two digits, enter the digits in sequence using the number keys.

④ STATUS Button

Displays event, recording device and network statuses.

⑤ LAYOUT Button

1x1 > 2x2 > 1+5 > 1+7 > 3x3 > 4x4 > 5x5 > 6x6

⑥ PTZ Control Buttons

Used in PTZ mode to zoom in/out on the screen and to shift focus between a nearby point and a far away point.

⑦ REGISTER MODE Button

Used in Live mode to access Camera Registration mode.

⑧ THUMBNAIL Button

Used in Playback mode to access Thumbnail Search mode. Thumbnail Search mode displays thumbnails of video recordings and allows you to search recordings based on date, time, minutes and seconds parameters.

⑨ CALENDAR Button

Displays a video recording playback screen that includes a calendar.

⑩ KEYLOCK Button

Locks out all remote control keys. To unlock, press the button again.

⑪ SETUP Button

Pressing the **SETUP** button while in Live mode displays the setup menu.

⑫ FREEZE Button

Used to pause Live screen.

⑬ LOG Button

Displays system log window and allows you to search the log.

14 Enter Button
Used to make menu option selections and register data entries. In addition, pressing this button while a camera screen is selected by pressing the **Menu** button in Live or Playback mode displays the Camera menu.

15 Arrow Buttons
Used to navigate through menus and interact with GUIs. In a Setup menu, use the **Up/Down Arrow** buttons to increase or decrease numerical values. In Live or Playback mode, use the **Left/Right Arrow** buttons to view the previous or next screen.

16 ALARM Button
Pressing this button while the alarm has been activated resets all NVR outputs, including the built-in buzzer. Displays the event log on the screen when the alarm is off in Live mode.

17 SEQUENCE Button
Pressing the **SEQUENCE** button while in Live mode initiates Live Sequential mode (displays channels in sequence).

18 ZOOM Button
Used to zoom in on a specific part of the screen. Once zoomed in, use the arrow buttons to pan around.

19 PTZ Button
Initiates PTZ mode and allows you to control the selected PTZ camera.

20 VIEW Button
Pressing the **VIEW** button while in PTZ mode displays the preset list.















21 SAVE Button
Press the **SAVE** button while in PTZ mode to save the current position as a preset.

22 MENU Button
Pressing the **MENU** button while in Live mode displays the Live menu. Alternatively, pressing the button while in Time-lapse Search mode displays the Control Area menu. Using the menu button in the control area, you can move the screen. **Top** by using this button in the **Control Area** menu displays the Search menu. For more information on the Control Area menu, refer to **Time-Lapse Search in the operation manual.**

Pressing and holding this button for 3 seconds activates One-Touch mode and displays the clip copy window while in Time-lapse Search mode. If the Search menu is displayed on the top of the screen, One-Touch mode is not activated.

Pressing the **MENU** button while in Thumbnail Search mode displays the Thumbnail Search menu.

23 Playback Buttons

| | |
|---|--|
|  | Scans backward through the video at a fast rate. (Press to cycle through  ,  , and  the speed) |
|  | Plays the video in normal speed and displays  on the screen. Pressing the  button during playback pauses the video and displays  on the screen. |
|  | Scans forward through the video at a fast rate. (Press to cycle through  ,  , and  the speed) |
|  | Stops the video and restores Live mode. |
|  | Skips to the previous screen (while in paused state). |
|  | Skips to the next screen (while in paused state). |

24 BOOKMARK Button
Adds a bookmark to the current playback position [in search mode.](#)

25 CLIP COPY Button
Used to perform Clip Copy.

26 MUTE Button
Temporarily disables audio.

Part 2 - Appendix

System Log Types

| | |
|-----------------------|-----------------------------|
| Boot Up | Panic On |
| System Shutdown | Panic Off |
| Restart | Clear All Data |
| Upgrade Success | Clear Disk |
| Upgrade Error | Format Disk |
| Power Failure | Disk Full |
| Time Changed | Auto Deletion |
| Time Zone Change | Search Begin |
| Time Sync. | Search End |
| Time Sync. Failed | Clip-Copy Begin |
| Disk Bad | Clip-Copy End |
| Login | Clip-Copy Cancel |
| Logout | Clip-Copy Failure |
| Setup Begin | Clip Copy User |
| Setup End | Clip-Copy Begin |
| Remote Setup Change | Clip-Copy Finished |
| Remote Setup Failure | Clip Copy Duration of Video |
| Setup Import | Clip Copy Camera |
| Setup Import Failure | Callback Failed |
| Setup Export | Factory Reset |
| Setup Export Failure | Camera Upgrade Begin |
| Setup Export Canceled | Camera Upgrade End |
| SNS Failure | Camera Upgrade Failure |
| Schedule On | Camera Upgrade User |
| Schedule Off | Camera Upgrade Camera |





Error Code Types

| Upgrade Error Codes | | | |
|---------------------|------------------------------|-----|--|
| No. | Type | No. | Type |
| 0 | Unknown Error | 301 | Remote Network Error |
| 1 | Incorrect File Version | 302 | No Remote Upgrade Permission |
| 2 | Incorrect OS Version | 303 | Remote Upgrade File Save Failure |
| 3 | Incorrect Software Version | 304 | Remote Upgrade Cancelled by User |
| 4 | Incorrect Kernel Version | 400 | USB Storage Device Mount Failure |
| 100 | Storage Device Mount Failure | 401 | USB Storage Device File Read Failure |
| 101 | File Not Found | 402 | USB Storage Device File Copy Failure |
| 102 | File Decompression Failure | 403 | USB Device Not Connected |
| 103 | LILO Execution Failure | 404 | USB Storage Device in Use |
| 104 | Reboot Failure | 405 | Unsupported File System |
| 105 | Improper File | 500 | Clip Copy in Progress: Upgrade Not Available |
| 300 | Remote Connection Failure | | |

| Clip Copy Error Codes | | | |
|------------------------------|-----------------------------------|-----|---|
| No. | Type | No. | Type |
| 0 | Unknown Error | 12 | Disk Error |
| 1 | Device Error | 13 | Clip Player Execution File Not Found |
| 2 | Device Connection Failure | 14 | Clip Player Execution File Access Failure |
| 3 | CD Media Not Found | 15 | Clip Player Execution File Save Failure |
| 4 | Incorrect Media | 16 | Image Generation Failure |
| 5 | File Name Taken | 17 | Burn Failure |
| 6 | Insufficient Space | 18 | Burn Time Overrun |
| 7 | Temporary File Generation Failure | 19 | Device Connection Failure |
| 8 | Disk Access Failure | 20 | Device in Use |
| 9 | Disk Format Failure | 21 | Unsupported File System |
| 10 | Database Changed | 22 | Data Validation Failure |
| 11 | Save Failure | 23 | No Saved Data within Range |

| Network Error Codes | | | |
|----------------------------|--|-----|--|
| No. | Type | No. | Type |
| 0 | Cause of Failure Unknown | 20 | Connection Cancelled by User |
| 1 | Normal Logout | 21 | No Response from Network Device Host |
| 2 | All Channels in Use - Connection Denied | 22 | High Network Noise Level |
| 3 | Incorrect Product Version Info | 23 | Transmission Queue Full |
| 4 | Incorrect User Name or Password | 24 | Incorrect OEM Info |
| 5 | Forced Disconnection by Admin | 25 | No Search Permission |
| 6 | Timeout | 26 | Port in Use |
| 7 | Network Device Terminated | 27 | SSL Connection Failure |
| 8 | Unable to Connect: No Available Port | 28 | Network Timeout |
| 9 | Server Not in Operation: Unable to Connect | 29 | Network Device Host Timeout |
| 11 | Network Unavailable | 30 | RTP via TCP Not Supported by Network Device Host |
| 12 | Different Network Zone: Unable to Access | 31 | Socket Error |
| 13 | Connection Timeout | 100 | Unknown CODEC |
| 14 | Forced Disconnection by Network Device | 101 | .jpeg CODEC (not supported) |
| 15 | Network Device Host Terminated | 103 | .mpeg4 CODEC (not supported) |
| 16 | Unable to Route to Network Device Host | 400 | Unsupported Resolution |
| 17 | Connection Severed | -1 | Normal Access |

Troubleshooting

| Problem | Solution |
|---|---|
| The main unit won't turn on. | <ul style="list-style-type: none"> • Check the power cable connection status. • Check the power outlet. |
| Unable to display Live video. | <ul style="list-style-type: none"> • Check the camera's video cable connection status. • Check the monitor's video cable connection status. • Check the camera's power setting. • Check the camera lens settings. |
| PoE-enabled camera will not turn on. | <ul style="list-style-type: none"> • Verify that the camera is actually PoE-enabled. • Check the network cable, replace it, and try again. |
| NVR stopped working in the middle of a recording. | <ul style="list-style-type: none"> • Hard disk may be full. Delete video recordings to free up space. • Set the NVR to Recycle mode. For more information, refer to the General in the operation manual. |
|  icon is shown, but video is not being recorded. | If the Pre-Event is enabled, the  and  icons appears when recording is not in progress, or the  and  icons appear when an event occurs and recording is in progress. For more information, refer to the Schedule in the operation manual . |
| The NVR keeps on rebooting during a system upgrade without completing the upgrade. | Check the upgrade file's version. To downgrade to a previous version, you must first press the factory reset button and reset all NVR settings to their factory defaults. A factory reset will clear all NVR settings configured by the user. For more information on factory reset, refer to the Factory Reset on page 16 . |

Specifications

These product specifications may change without prior notice.

| General | |
|--|------------------------|
| Exterior Dimensions (W x H x D) | 430mm x 88mm x 410.8mm |
| Weight (Main Unit) | 9.0kg(with 1HDD) |
| Working Temperature | 0°C – 40°C |
| Operating Humidity | 0% – 90% |
| Power | 100V~240V |
| Power Consumption | Max. 200W(with 6HDDs) |
| Certifications | FCC, CE, CB, UL |

| Video | |
|------------------------------|--|
| Video In | Network camera or video encoder* (Video In Port : 8, Channel: 16/32) |
| Monitor Out | HDMI: 1 HDMI VGA: 1 DB15 |
| Video Resolution | 1920x1200, 1920x1080, 1680x1050, 1600x1200 |
| Recording Speed (IPS) | 960ips @ Full HD (DR-6232P-S) 480ips @ Full HD (DR-6216P-S) |
| Playback Speed (IPS) | 120ips @ Full HD |

* If more than 16 cameras from video encoders are registered on the NVR, video may not be displayed smoothly in a remote program.

| I/O | |
|---------------------------|--|
| Alarm In | 4 TTL, NC/NO programmable, 2.4V (NC) or 0.3V (NO) threshold, 5V DC |
| Alarm Out | 1 relay output, NC/NO, 2A@125V AC, 1A@30V DC |
| Alarm Reset In | 1 TTL, terminal block |
| Internal Buzzer | 78dB at 10cm |
| Network Connection | 10Mbps/100Mbps/1Gbps Ethernet |
| Audio In | 1 line, RCA |
| Audio Out | 1 line, RCA |
| Text In | POS Interface, ATM Interface |

| Connectors | |
|-------------------------|-----------------------------|
| Video In | Ethernet: 9 ports |
| Camera Power Out | Ethernet: 8 ports |
| Monitor Out | HDMI: 1 HDMI VGA: 1 DB15 |
| Audio In | 1 RCA connector |
| Audio Out | 1 RCA connector |
| Alarm | Terminal block |

| | |
|-------------------------------|---|
| Ethernet Port | 1 RJ-45 |
| eSATA Ports | 4 eSATA Ports |
| RS-232 Serial Port | Terminal block, text insertion (POS/ATM) |
| RS-485 Serial Port | Terminal block, telemetry control, remote control keyboard (programmable) |
| IR Remote Control Port | Remote Control |
| USB Ports | 2 x USB 2.0 (5V, less than 0.5A) |
| Storage | |
| Internal Storage | 6 SATA2 bays |
| External Storage | 4 eSATA ports |
| Clip Copy Device | USB Storage Device (USB HDD, USB Memory, etc.) |



Some hard disks may not function properly when mounted on to this product. Refer to the compatibility chart below before mounting any additional hard disk on to the product. Hard disk compatibility chart is subject to change without notice. Contact your retailer for the latest compatibility chart.

| Storage | Manufacturer | Model | Note |
|----------------|---------------------|------------------|-------------|
| 1TB | Seagate | ST31000322CS | |
| | Western Digital | WD10PURX-64D85Y0 | |
| | TOSHIBA | DT01ACA100 | |
| 2TB | Seagate | ST2000VM003 | |
| | Western Digital | WD20PURX-64P6ZY0 | |
| | TOSHIBA | DT01ACA200 | |
| 3TB | Seagate | ST3000VX000 | |
| | Western Digital | WD30PURX-64P6ZY0 | |
| | TOSHIBA | DT01ACA300 | |
| 4TB | Western Digital | WD40PURX-64GVNY0 | |
| 5TB | Western Digital | WD50PURX-64LZMY0 | |
| 6TB | Western Digital | WD60PURX-64LZMY0 | |



IDIS Co., Ltd.

For more information, please visit at
www.idisglobal.com