



DC-E Series

Installation Manual

DC-E1112WR/DC-E1212WR



Powered by **Direct IP™**

Before reading this manual



This is a basic installation manual for use of an IDIS network camera. Users who are using this product for the first time, as well as users with experience using comparable products, must read this operation manual carefully before use and heed to the warnings and precautions contained herein while using the product. Safety warnings and precautions contained in this operation manual are intended to promote proper use of the product and thereby prevent accidents and property damage and must be followed at all times. Once you have read this operation manual, keep it at an easily accessible location for future reference.

-  The manufacturer will not be held responsible for any product damage resulting from the use of unauthorized parts and accessories or from the user's failure to comply with the instructions contained in this manual.
- The information in this document is believed to be accurate as of the date of publication. The manufacturer is not responsible for any problems resulting from the use thereof. The information contained herein is subject to change without notice. Revisions or new editions to this publication may be issued to incorporate such changes.
- It is recommended that first-time users of this network camera and individuals who are not familiar with its use seek technical assistance from their retailer regarding product installation and use.
- If you need to disassemble the product for functionality expansion or repair purposes, you must contact your retailer and seek professional assistance.
- Both retailers and users should be aware that this product has been certified as being electromagnetically compatible for commercial use. If you have sold or purchased this product unintentionally, please replace with a consumer version.

Safety Symbols

Symbol	Type	Description
	Warning	An important instruction or set of important instructions that can lead to severe injury or even death if not followed.
	Caution	An instruction or set of instruction that can lead to personal injury and/or property damage if not followed.

In-Text

Symbol	Type	Description
	Caution	Important information concerning a specific function.
	Note	Useful information concerning a specific function.

Safety Precautions

WARNING

RISK OF ELECTRIC SHOCK
DO NOT OPEN

WARNING: TO REDUCE THE RISK OF ELECTRIC SHOCK,
DO NOT REMOVE COVER (OR BACK).
NO USER-SERVICEABLE PARTS INSIDE.
REFER SERVICING TO QUALIFIED SERVICE PERSONNEL.

Important Safeguards

1. Read Instructions

All the safety and operating instructions should be read before the appliance is operated.

2. Retain Instructions

The safety and operating instructions should be retained for future reference.

3. Cleaning

Unplug this equipment from the wall outlet before cleaning it. Do not use liquid aerosol cleaners. Use a damp soft cloth for cleaning.

4. Attachments

Never add any attachments and/or equipment without the approval of the manufacturer as such additions may result in the risk of fire, electric shock or other personal injury.

5. Water and/or Moisture

Do not use this equipment near water or in contact with water.

6. Placing and Accessories

Do not place this equipment on a wall or ceiling that is not strong enough to sustain the camera. The equipment may fall, causing serious injury to a child or adult, and serious damage to the equipment. Wall or shelf mounting should follow the manufacturer's instructions, and should use a mounting kit approved by the manufacturer.



This equipment and cart combination should be moved with care. Quick stops, excessive force, and uneven surfaces may cause the equipment and cart combination to overturn.

Do not place this equipment in an enclosed space. Sufficient ventilation is required to prevent an increase in ambient temperature which can cause malfunction or the risk of fire.

7. Power Sources

This equipment should be operated only from the type of power source indicated on the marking label. If you are not sure of the type of power, please consult your equipment dealer or local power company.

You may want to install a UPS (Uninterruptible Power Supply) system for safe operation in order to prevent damage caused by an unexpected power stoppage. Any questions concerning UPS, consult your UPS retailer.

8. Power Cord

Operator or installer must remove power and TNT connections before handling the equipment.

9. Lightning

For added protection for this equipment during a lightning storm, or when it is left unattended and unused for long periods of time, unplug it from the wall outlet and disconnect the antenna or cable system. This will prevent damage to the equipment due to lightning and power-line surges. If thunder or lightning is common where the equipment is installed, use a surge protection device.

10. Overloading

Do not overload wall outlets and extension cords as this can result in the risk of fire or electric shock.

11. Objects and Liquids

Never push objects of any kind through openings of this equipment as they may touch dangerous voltage points or short out parts that could result in a fire or electric shock. Never spill liquid of any kind on the equipment.

12. Servicing

Do not attempt to service this equipment yourself. Refer all servicing to qualified service personnel.

13. Damage requiring Service

Unplug this equipment from the wall outlet and refer servicing to qualified service personnel under the following conditions:

- When the power-supply cord or the plug has been damaged.
- If liquid is spilled, or objects have hit the equipment.
- If the equipment has been exposed to rain or water.
- If the equipment does not operate normally by following the operating instructions, adjust only those controls that are covered by the operating instructions as an improper adjustment of other controls may result in damage and will often require extensive work by a qualified technician to restore the equipment to its normal operation.
- If the equipment has been dropped, or the cabinet damaged.
- When the equipment exhibits a distinct change in performance — this indicates a need for service.

14. Replacement Parts

When replacement parts are required, be sure the service technician has used replacement parts specified by the manufacturer or that have the same characteristics as the original part. Unauthorized substitutions may result in fire, electric shock or other hazards.

15. Safety Check

Upon completion of any service or repairs to this equipment, ask the service technician to perform safety checks to determine that the equipment is in proper operating condition.

16. Field Installation

This installation should be made by a qualified service person and should conform to all local codes.

17. Correct Batteries

Warning: Risk of explosion if battery is replaced by an incorrect type. Dispose of used batteries according to the instructions.

18. Tmra

A manufacturer's maximum recommended ambient temperature (Tmra) for the equipment must be specified so that the customer and installer may determine a suitable maximum operating environment for the equipment.

FCC Compliance Statement

THIS EQUIPMENT HAS BEEN TESTED AND FOUND TO COMPLY WITH THE LIMITS FOR A CLASS A DIGITAL DEVICE, PURSUANT TO PART 15 OF THE FCC RULES. THESE LIMITS ARE DESIGNED TO PROVIDE REASONABLE PROTECTION AGAINST HARMFUL INTERFERENCE WHEN THE EQUIPMENT IS OPERATED IN A COMMERCIAL ENVIRONMENT. THIS EQUIPMENT GENERATES, USES, AND CAN RADIATE RADIO FREQUENCY ENERGY AND IF NOT INSTALLED AND USED IN ACCORDANCE WITH THE INSTRUCTION MANUAL, MAY CAUSE HARMFUL INTERFERENCE TO RADIO COMMUNICATIONS. OPERATION OF THIS EQUIPMENT IN A RESIDENTIAL AREA IS LIKELY TO CAUSE HARMFUL INTERFERENCE, IN WHICH CASE USERS WILL BE REQUIRED TO CORRECT THE INTERFERENCE AT THEIR OWN EXPENSE.

WARNING: CHANGES OR MODIFICATIONS NOT EXPRESSLY APPROVED BY THE PARTY RESPONSIBLE FOR COMPLIANCE COULD VOID THE USER'S AUTHORITY TO OPERATE THE EQUIPMENT. THIS CLASS OF DIGITAL APPARATUS MEETS ALL REQUIREMENTS OF THE CANADIAN INTERFERENCE CAUSING EQUIPMENT REGULATIONS.

WEEE (Waste Electrical & Electronic Equipment)

Correct Disposal of This Product

(Applicable in the European Union and other European countries with separate collection systems)



This marking shown on the product or its literature, indicates that it should not be disposed with other household wastes at the end of its working life. To prevent possible harm to the environment or human health from uncontrolled waste disposal, please separate this from other types of wastes and recycle it responsibly to promote the sustainable reuse of material resources.

Household users should contact either the retailer where they purchased this product, or their local government office, for details of where and how they can take this item for environmentally safe recycling.

Business users should contact their supplier and check the terms and conditions of the purchase contract. This product should not be mixed with other commercial wastes for disposal.

Copyright

© 2014 IDIS Co., Ltd.

IDIS Co., Ltd. reserves all rights concerning this operation manual.

Use or duplication of this operation manual in part or whole without the prior consent of IDIS Co., Ltd. is strictly prohibited.

Contents of this operation manual are subject to change without prior notice for reasons such as functionality enhancements.

Registered Trademarks

IDIS is a registered trademark of IDIS Co., Ltd.

Other company and product names are registered trademarks of their respective owners.

This product contains software built partially on open-source content. Codes for the corresponding open-source content are available for download. For more information, refer to the software CD (OpenSourceGuide\OpenSourceGuide.pdf) or the open source guide accompanying this operation manual.

Table of Contents

1

Part 1 – Introduction.....	6
Product Features	6
Accessories.....	7
Overview	8
Body.....	8
Waterproof Sealing.....	8
Sun Shield	9
Bracket	9
Cable	9
Factory Reset	10
Installation	11
Installation.....	11
Dimensions.....	11

2

Part 2 - Camera Connection	12
With DirectIP™ NVR-based Layout.....	12
With non DirectIP™ NVR-based Layout	13

3

Part 3 - Appendix.....	14
Troubleshooting	14
Specifications	15

Part 1 – Introduction

Product Features

DC-E1112WR / DC-E1212WR are IP-based network cameras that compress and transmit video over ethernet.

You can use the IDIS Discovery program to change network camera settings or the IDIS Solution Suite Compact program to manage multiple network cameras. In addition, the embedded web server (IDIS Web) lets you remotely view live video using a web browser. In addition, you can use the IDIS Solution Suite Compact to manage network cameras and view/record video.



In this operation manual, the term **Remote System** refers to the computer on which the remote program (IDIS Solution Suite Compact or IDIS Web) is running.

- Supports DirectIP mode working with a DirectIP™ NVR that allows users to simply set up all required configurations without a PC
- Supports ONVIF protocol (v2.2.0)
- Multi-streaming for high-resolution and high-quality video monitoring and simultaneous recording in real-time as well as flexible configurations for those
- Supports H.264 video compression and M-JPEG still image compression algorithms
- Supports 4-stage video compression rate and multiple compression resolutions
- Video stream buffering to counter pre-/post-event buffering and network delays for improved network recording reliability
- Remote monitoring via web browser or remote software
- Automatic web casting code (HTML) generation
- Up to 10 simultaneous remote monitoring connections

- IP filtering, HTTPS, SSL, IEEE 802.1X, and configurable user authority levels for greater security
- Network bandwidth limitation and MAT features for more efficient use of network bandwidth
- Easy network access via UPnP (Universal Plug and Play) function and embedded mDNS (Multicast DNS) protocol
- Wide dynamic range compensation (Digital WDR) for improved video quality in high-contrast situations
- Slow shutter support for improved low-lighting video capture performance
- Quick and easy firmware upgrade over the network
- Redundant firmware and auto recovery features for improved system stability
- Network-based integrated management of multiple network cameras
- Multiple event detection modes: Motion Detection, Trip Zone, and Tampering
- Supports PoE (Power over Ethernet)
- Video out feature (selectable NTSC/PAL)



Remote monitoring and recording via multistreaming are available using the IDIS Solution Suite Compact program. For more information on using IDIS Solution Suite Compact, refer to its **operation manual**.



There is a limit to the number of users allowed to connect remotely via the Internet at the same time.

Accessories

Upon purchasing the product, check inside the box to make sure all the following accessories are included. External appearances and colors of the accessories may vary depending on the model.

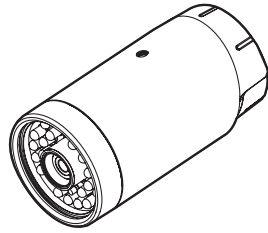

Network Camera

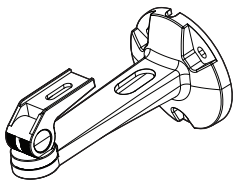

Bracket

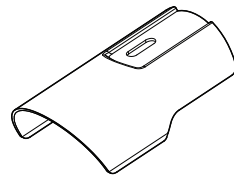

Sun Shield

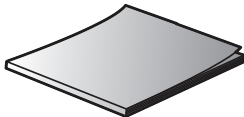

Open Source Guide

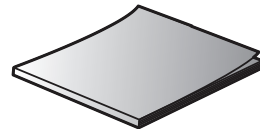

Quick Guide



Sun Shield Screw (1 ea.)

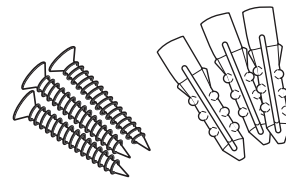

Screws (3 ea.)

Overview

Product color and design may vary depending on the model.

Body

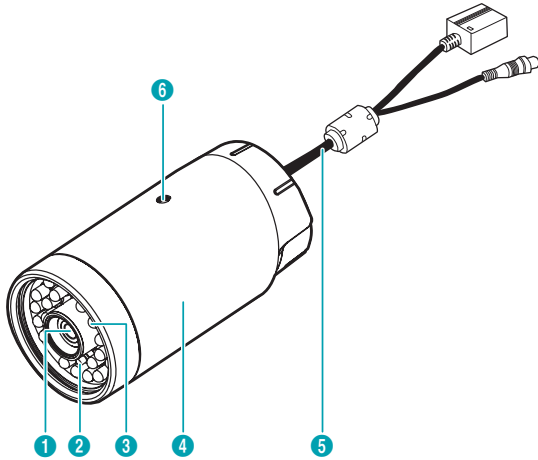

1	Lens
2	Factory Reset Switch (White)
3	IR LED
4	Body
5	Cable
6	Sun Shield Screw Hole

- **Lens**
Fixed lens is installed.
- **Factory Reset Switch (White)**
Restores the camera's default factory settings. For more information, refer to the **Factory Reset**.
- **IR LED**
The sensor (black) in the upper middle detects low illumination and the IR LEDs are lit at night or under low lighting conditions.
- **Body**
The cables are connected through the body.

- **Cable**
Refer to the **Cable**.
- **Sun Shield Screw Hole**
Allows you to screw the sun shield to the camera.

Camera surveillance may be prohibited by laws that vary by region. Check the laws in your area before using this product for surveillance purposes.

Waterproof Sealing

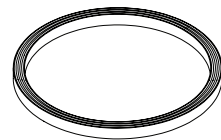

The waterproof sealing (black rubber) is attached inside of the camera.

! Make sure that the waterproof sealing is held into the camera body tightly when reconnecting the lid after removing it to perform a factory reset. If the waterproof sealing is not held into the camera body properly, the IP66 level is not guaranteed. For more information, contact your product retailer.

Sun Shield

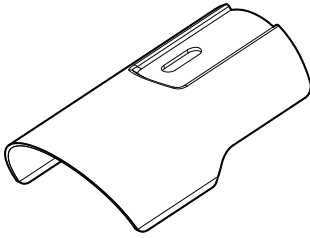

Bracket

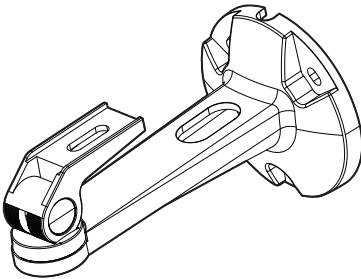

Cable

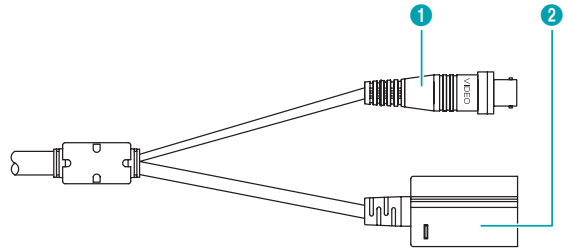

1	Video Out (BNC)
2	Network Port

- **Video Out (BNC)**

Connect the monitor. Use these ports for previewing video and not monitoring video.

- **Network Port**

Connect a network cable with an RJ-45 connector to this port. If using a PoE switch, you can supply power to the camera using an ethernet cable. For more information on PoE switch use, refer to the switch manufacturer's operation manual. You can configure, manage, and upgrade this camera and monitor its images from a remote computer over the network. For more information on network connection setup, refer to the **IDIS Discovery operation manual**.



- Check your local laws and regulations on making video recordings. The user will be held liable for any violation of the law. (Article 25-5 of the Personal Information Protection Act: Operators of image data processing devices may not operate such devices for purposes other than as originally intended during device installation, place such devices at locations other than as originally intended, or use such devices to record audio.)
- The network connector is not designed to be connected directly with cable or wire intended for outdoor use.

Factory Reset

Only use the factory reset switch to restore the camera to its factory default settings.



A factory reset will clear all camera settings configured by the user.

- 1 Shut off the power supply, separate the lid of the camera front by turning it counterclockwise. Insert a straight pin into the switch hole, and press down on the reset switch.
- 2 Hold the switch down and reconnect the power.
- 3 After connecting the power, wait 5 seconds and then take out hands from the switch.
- 4 The device will go through the resetting process and reboot. All camera settings will be restored to their factory defaults after the reboot.
- 5 Reconnect the lid of the camera front.

It's also possible to do a factory reset by pressing and releasing the reset switch while the camera is turned on or using the IDIS Discovery program from a remote location. A factory reset will reboot the system. For more information on resetting the camera remotely, refer to the **IDIS Discovery operation manual**.



Make sure that the waterproof sealing is fixed properly to the camera body when reconnecting the lid. Otherwise, the IP66 level is not guaranteed. For more information, contact your product retailer.

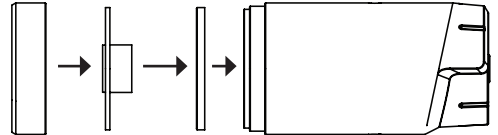

Installation

Installation of this product does not require the use of special tools.

For more information on other devices comprising the overall system, refer to their respective **installation manuals**.

 Product color and design may vary depending on the model.

Installation

 Check the wall or ceiling to see if it needs to be reinforced. The camera may fall off if the wall or ceiling is not strong enough to support its weight.

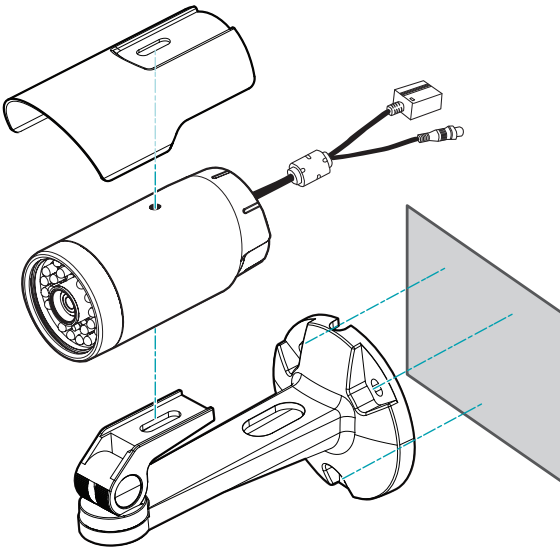

- 1 Screw the sun shield to the camera body by using the mounting screws provided with the camera.
- 2 Screw the camera body to the bracket by using the mounting screws provided with the camera.
- 3 Connect external devices and the network cable.
- 4 Screw the bracket to the wall or ceiling by using the mounting screws provided with the camera.

Dimensions

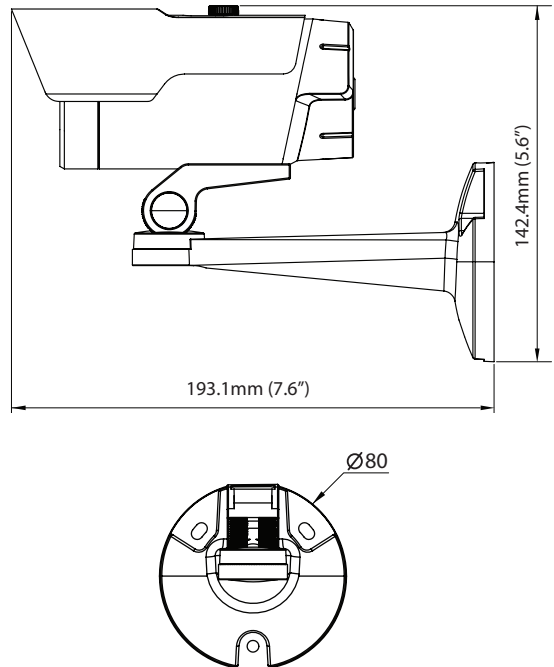

Part 2 - Camera Connection

Use the camera by connecting to DirectIP™ NVR or non DirectIP™ NVR, VMS such as IDIS Solution Suite Compact.

With DirectIP™ NVR-based Layout

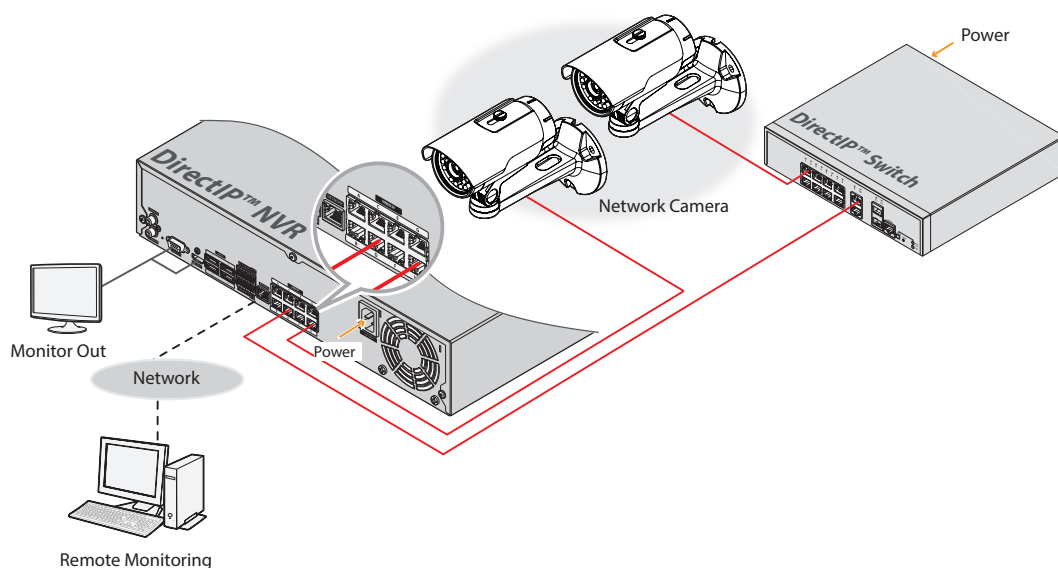

DirectIP™ NVR makes it easy to use cameras without extra network configurations. Each camera can be controlled via the DirectIP™ NVR setup menu, without any PC. For detailed camera settings, please see the camera setting pages of DirectIP™ NVR manual.

For users using the camera with DirectIP™ NVR connection, do not need to consider contents in the camera operation manual.

With non DirectIP™ NVR-based Layout

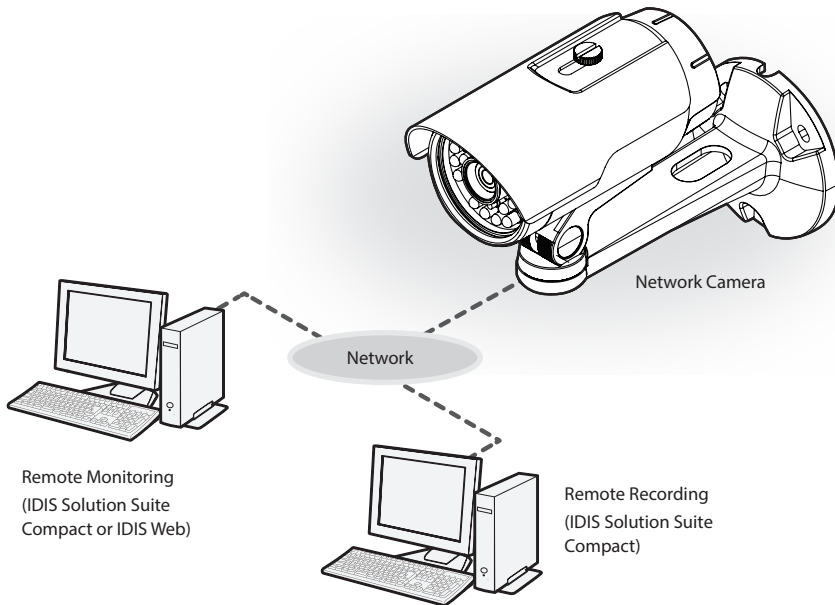

Control the camera over the network from software installed on a computer.
Ideal for using the camera over the network from a remote location.

The contents in the camera operation manual are only for users using the camera with non DirectIP™ NVR connection or VMS connection such as IDIS Solution Suite Compact.

Part 3 - Appendix

Troubleshooting

Problem	Check
The main unit won't turn on.	<ul style="list-style-type: none">• Check the power cable connection.• Check the power outlet.
PoE switch isn't being recognized.	Check the grounding status of the I/O device connected to the camera and the PoE switch. If they are not grounded, ground them and try again.
I can't see Live videos.	<ul style="list-style-type: none">• Check the camera's power status.• Check the network connection status of the computer and the network camera.
Images are blurry.	<ul style="list-style-type: none">• Make sure the lens is clean. If not, clean it using a soft piece of cloth or a brush.• If there is too much light coming into the camera or the camera is picking up an overly bright light source, adjust the camera's position/angle accordingly.
Video color appears incorrect.	Check the white balance settings. If using the Auto option, it may take some time for the white balance to be adjusted.
Images are blinking.	If the camera is pointed at the sun or a fluorescent lamp, adjust the camera's angle away.
Lost the admin ID and password and unable to connect to a network camera.	You must perform a factory reset. A factory reset will revert all settings, including network settings, to their factory defaults. After performing a factory reset, make a memo of the admin ID and password as a safety precaution.
Unable to launch IDIS Web.	If the IDIS Web login screen is not loading, check which version of Microsoft Internet Explorer you are using. IDIS Web may not launch properly on versions 8.0 or below.

Specifications



These product specifications may change without prior notice.

Lens

Lens Type	Fixed Focus Lens: F2.0
Focal Length	6.0mm
Viewing Angle	H: 58.2° V: 31.6° D: 67.2°

Camera

Image Sensor	1/2.7" CMOS
Minimum Subject Lux	IR LED OFF : 1 Lux @ F2.0 IR LED ON : 0 Lux @ F2.0
Scanning Method	Progressive scan
Signal-to-Noise Ratio	> 45 dB
Dynamic Range (Digital WDR)	> 90 dB
IR LED	LED x 24 (850 nm)
Lighting Sensor	Supported
IR Range	10 m

Video

Signal Format	NTSC or PAL (programmable)	
Compression Algorithm	H.264, M-JPEG (Four levels)	
Compression Resolution	DC-E1112WR	352x240, 704x480, 1280x720
	DC-E1212WR	352x240, 704x480, 1280x720, 1920x1080
Bitrate Control	DC-E1112WR	H.264 –CBR / VBR (up to 8 Mbps)
	DC-E1212WR	H.264 –CBR / VBR (up to 12 Mbps)
Max. Transmission Rate (frames per second)	DC-E1112WR	30 ips @ 1280x720 + 30 ips @ 1280x720
	DC-E1212WR	30 ips @ 1920x1080 + 4 ips @ 1920x1080
Multi-Stream	Primary, Secondary, Tertiary, Quaternary	

I/O

Audio Out	1 Line Out
Network Connection	10/100 Mbps Ethernet

Connector

Video Out**	BNC
Ethernet Port	RJ-45

** Use these ports for previewing video and not monitoring video.

General

External Dimensions (Ø x H)	2.36" x 4.63" (60mm x 117.5mm)	
Packaging Dimensions (W x H x D)	7.87" x 6.65" x 5" (200mm x 169mm x 127mm)	
Weight (Main Unit)	1.12 lbs. (0.51kg)	
Weight (Packaging)	2.31 lbs. (1.05kg)	
Working Temperature	DC-E1112WR	14°F to 122°F (-10°C to 50°C) (Starting temperature: 32°F to 122°F (0°C to 50°C))
	DC-E1212WR	With IR LED on: 14°F to 113°F (-10°C to 45°C) (Starting temperature: 32°F to 122°F (0°C to 50°C))
Operating Humidity	0% ~ 90%	
Power Input	PoE(IEEE 802.3af, Class2)	
Power Consumption	Max. 6.4W	
Certifications	FCC, CE, IP66	



IDIS Co., Ltd.

For more information, please visit at
www.idisglobal.com