



DirectCX Camera

Installation Manual

TC-B5501X



TC-B5501XP

Before reading this manual



This is a basic installation manual for use of an IDIS camera. Users who are using this product for the first time, as well as users with experience using comparable products, must read this manual carefully before use and heed to the warnings and precautions contained herein while using the product. Safety warnings and precautions contained in this manual are intended to promote proper use of the product and thereby prevent accidents and property damage and must be followed at all times. Once you have read this manual, keep it at an easily accessible location for future reference.

-  • The manufacturer will not be held responsible for any product damage resulting from the use of unauthorized parts and accessories or from the user's failure to comply with the instructions contained in this manual.
- The information in this document is believed to be accurate as of the date of publication. The manufacturer is not responsible for any problems resulting from the use thereof. The information contained herein is subject to change without notice. Revisions or new editions to this publication may be issued to incorporate such changes.
- It is recommended that first-time users of this camera and individuals who are not familiar with its use seek technical assistance from their retailer regarding product installation and use.
- If you need to disassemble the product for functionality expansion or repair purposes, you must contact your retailer and seek professional assistance.
- Both retailers and users should be aware that this product has been certified as being electromagnetically compatible for commercial use. If you have sold or purchased this product unintentionally, please replace with a consumer version.

Safety Symbols

Symbol	Type	Description
	IEC60417, No.5031	Direct current
	IEC60417, No.5032	Alternating current

In-Text

Symbol	Type	Description
	Caution	Important information concerning a specific function.
	Note	Useful information concerning a specific function.

Safety Precautions

WARNING

RISK OF ELECTRIC SHOCK
DO NOT OPEN

WARNING: TO REDUCE THE RISK OF ELECTRIC SHOCK,
DO NOT REMOVE COVER (OR BACK).
NO USER-SERVICEABLE PARTS INSIDE.
REFER SERVICING TO QUALIFIED SERVICE PERSONNEL.

Important Safeguards

1. Read Instructions

All the safety and operating instructions should be read before the appliance is operated.

2. Retain Instructions

The safety and operating instructions should be retained for future reference.

3. Cleaning

Unplug this equipment from the wall outlet before cleaning it. Do not use liquid aerosol cleaners. Use a damp soft cloth for cleaning.

4. Attachments

Never add any attachments and/or equipment without the approval of the manufacturer as such additions may result in the risk of fire, electric shock or other personal injury.

5. Water and/or Moisture

Do not use this equipment near water or in contact with water.

6. Placing and Accessories

Do not place this equipment on an wall or ceiling that is not strong enough to sustain the camera. The equipment may fall, causing serious injury to a child or adult, and serious damage to the equipment. Wall or shelf mounting should follow the manufacturer's instructions, and should use a mounting kit approved by the manufacturer.



This equipment and cart combination should be moved with care. Quick stops, excessive force, and uneven surfaces may cause the equipment and cart combination to overturn.

Do not place this equipment in an enclosed space. Sufficient ventilation is required to prevent an increase in ambient temperature which can cause malfunction or the risk of fire.

7. Power Sources

This equipment should be operated only from the type of power source indicated on the marking label. If you are not sure of the type of power, please consult your equipment dealer or local power company.

You may want to install a UPS (Uninterruptible Power Supply) system for safe operation in order to prevent damage caused by an unexpected power stoppage. Any questions concerning UPS, consult your UPS retailer.

This equipment should be remain readily operable.

8. Power Cord

Operator or installer must remove power and TNT connections before handling the equipment.

9. Lightning

For added protection for this equipment during a lightning storm, or when it is left unattended and unused for long periods of time, unplug it from the wall outlet and disconnect the antenna or cable system. This will prevent damage to the equipment due to lightning and power-line surges. If thunder or lightning is common where the equipment is installed, use a surge protection device.

10. Overloading

Do not overload wall outlets and extension cords as this can result in the risk of fire or electric shock.

11. Objects and Liquids

Never push objects of any kind through openings of this equipment as they may touch dangerous voltage points or short out parts that could result in a fire or electric shock. Never spill liquid of any kind on the equipment.

12. Servicing

Do not attempt to service this equipment yourself. Refer all servicing to qualified service personnel.

13. Damage requiring Service

Unplug this equipment from the wall outlet and refer servicing to qualified service personnel under the following conditions:

- A. When the power-supply cord or the plug has been damaged.
- B. If liquid is spilled, or objects have hit the equipment.
- C. If the equipment has been exposed to rain or water.
- D. If the equipment does not operate normally by following the operating instructions, adjust only those controls that are covered by the operating instructions as an improper adjustment of other controls may result in damage and will often require extensive work by a qualified technician to restore the equipment to its normal operation.
- E. If the equipment has been dropped, or the cabinet damaged.
- F. When the equipment exhibits a distinct change in performance — this indicates a need for service.

14. Replacement Parts

When replacement parts are required, be sure the service technician has used replacement parts specified by the manufacturer or that have the same characteristics as the original part. Unauthorized substitutions may result in fire, electric shock or other hazards.

15. Safety Check

Upon completion of any service or repairs to this equipment, ask the service technician to perform safety checks to determine that the equipment is in proper operating condition.

16. Field Installation

This installation should be made by a qualified service person and should conform to all local codes.

17. Correct Batteries

Warning: Risk of explosion if battery is replaced by an incorrect type. Replace only with the same or equivalent type.

Dispose of used batteries according to the instructions.

The battery shall not be exposed to excessive heat such as sunshine, fire or the like.

18. Tmra

A manufacturer's maximum recommended ambient temperature (Tmra) for the equipment must be specified so that the customer and installer may determine a suitable maximum operating environment for the equipment.

FCC Compliance Statement

THIS EQUIPMENT HAS BEEN TESTED AND FOUND TO COMPLY WITH THE LIMITS FOR A CLASS A DIGITAL DEVICE, PURSUANT TO PART 15 OF THE FCC RULES. THESE LIMITS ARE DESIGNED TO PROVIDE REASONABLE PROTECTION AGAINST HARMFUL INTERFERENCE WHEN THE EQUIPMENT IS OPERATED IN A COMMERCIAL ENVIRONMENT. THIS EQUIPMENT GENERATES, USES, AND CAN RADIATE RADIO FREQUENCY ENERGY AND IF NOT INSTALLED AND USED IN ACCORDANCE WITH THE INSTRUCTION MANUAL, MAY CAUSE HARMFUL INTERFERENCE TO RADIO COMMUNICATIONS. OPERATION OF THIS EQUIPMENT IN A RESIDENTIAL AREA IS LIKELY TO CAUSE HARMFUL INTERFERENCE, IN WHICH CASE USERS WILL BE REQUIRED TO CORRECT THE INTERFERENCE AT THEIR OWN EXPENSE. **WARNING:** CHANGES OR MODIFICATIONS NOT EXPRESSLY APPROVED BY THE PARTY RESPONSIBLE FOR COMPLIANCE COULD VOID THE USER'S AUTHORITY TO OPERATE THE EQUIPMENT. THIS CLASS OF DIGITAL APPARATUS MEETS ALL REQUIREMENTS OF THE CANADIAN INTERFERENCE CAUSING EQUIPMENT REGULATIONS.

WEEE (Waste Electrical & Electronic Equipment)

Correct Disposal of This Product

(Applicable in the European Union and other European countries with separate collection systems)



This marking shown on the product or its literature, indicates that it should not be disposed with other household wastes at the end of its working life. To prevent possible harm to the environment or human health from uncontrolled waste disposal, please separate this from other types of wastes and recycle it responsibly to promote the sustainable reuse of material resources.

Household users should contact either the retailer where they purchased this product, or their local government office, for details of where and how they can take this item for environmentally safe recycling.

Business users should contact their supplier and check the terms and conditions of the purchase contract. This product should not be mixed with other commercial wastes for disposal.

Copyright

© 2020 IDIS Co., Ltd.

IDIS Co., Ltd. reserves all rights concerning this manual.

Use or duplication of this manual in part or whole without the prior consent of IDIS Co., Ltd. is strictly prohibited.

Contents of this manual are subject to change without prior notice for reasons such as functionality enhancements.

Registered Trademarks

IDIS is a registered trademark of IDIS Co., Ltd.

Other company and product names are registered trademarks of their respective owners.

The information in this manual is believed to be accurate as of the date of publication even though explanation about some functions may not be incorporated. We are not responsible for any problems resulting from the use thereof. The information contained herein is subject to change without notice. Revisions or new editions to this publication may be issued to incorporate such changes.

Table of Contents

1

Part 1 – Introduction.....	6
Product Features	6
Accessories.....	7
Overview	8
Body.....	8
Rear	9
Installation	10
CS-Mount Lens.....	10
C-Mount Lens.....	10
Mounting.....	10
Dimensions.....	11

2

Part 2 - Camera Connection	12
DirectCX DVR Layout	12

3

Part 3 - Appendix.....	14
Troubleshooting	14
Specifications	15

Part 1 – Introduction

Product Features

TC-B5501X/XP is an analog camera that transmits video over coaxial.

- Support for DC 12V and PoC (coaxial force)
PoC: TC-B5501XP Model Only
- Wide dynamic range compensation (True WDR) for improved video quality in high-contrast situations
- Support TVI/AHD/SD video output
- Supports fog removal
- Sense-Up support for improved low-lighting video capture performance
- Day & Night feature (built-in IR cut filter changer)
- Event detection mode: Motion detection
- C/CS mount lens connection support

Accessories

Upon purchasing the product, check inside the box to make sure all the following accessories are included. External appearances and colors of the accessories may vary depending on the model.

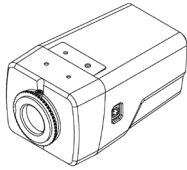

Camera

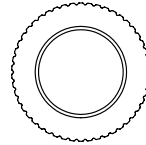

C-Mount Ring

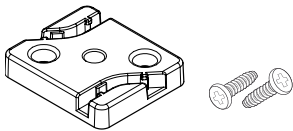

Installation Parts

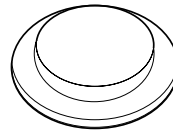

Protective Cover (attaches to camera)

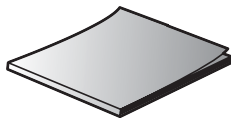

Quick Guide

Overview

Product color and design may vary depending on the model.

Body

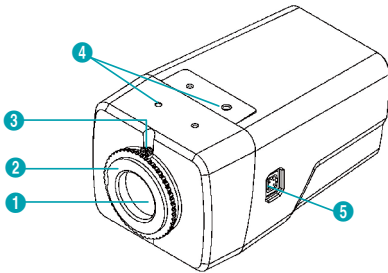

1	Image Sensor
2	CS - Mount Ring
3	CS - Mount Ring Screw
4	Mount Bracket Installation Hole
5	Auto Iris Lens Connector

• **Image Sensor**
Converts optical Image into electronic signals.

If the lens is not attached to the camera, use the protective cover to protect the image sensor.

• **CS-Mount Ring**
Used to tighten the CS mount lens and adjust the Back Focus.

• **CS-Mount Ring Screw**
Used to secure the mount ring after adjusting the Back Focus

• **Mount Bracket Installation Hole**
This bracket can be installed on either top or bottom of the camera. Use 1/4–20 UNC (20-thread), 2.5mm +/- 0.2mm (ISO standard), or 0.197 (ASA standard) standard screw.

• **Auto Iris lens Connector**
If using the DC type automatic Iris lens, connect the automatic Iris jack.

Connect only by using a lens with a long auto iris jack.

Rear

TC-B5501XP

TC-B5501X

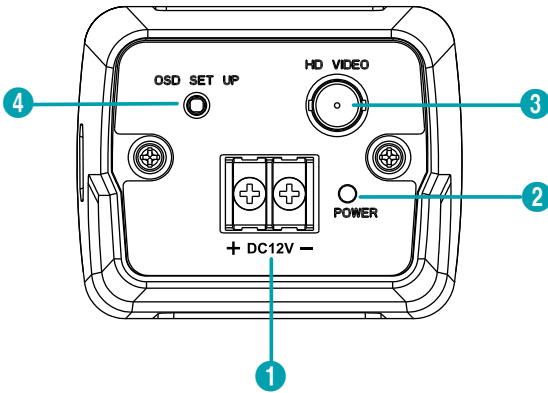

1	Power (DC 12V)
2	Power LED
3	BNC Video Out
4	OSD button

- Power (DC 12V)**
 Connect to the power adapter. (DC 12V) The power distinguishes + and -.
- Power LED**
 Displays the system operating status.
- BNC Video Out**
 Connect to the DVR.
- OSD button**
 Used to set the OSD menu.

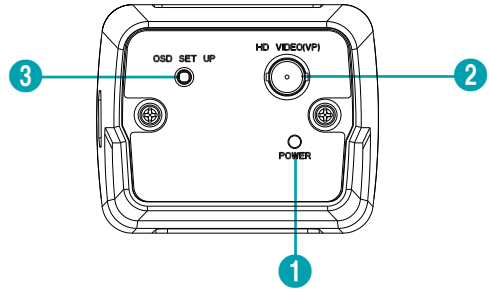

1	Power LED
2	BNC Video Out
3	OSD button

- Power LED**
 Displays the system operating status.
- BNC Video Out**
 Connect to the PoC Power unit
- For TC-B5501XP products, CVBS output is available for a preview only when the camera is being installed.
- OSD button**
 Used to set the OSD menu.

- The following table describes the coaxial cable specifications.

〈The coaxial cable specifications〉

Item	Content		Note
Conector	BNC		
Cable	3C-2V	5C-2V	
Maximum Length	300m	500m	

- The Power LED Status Indication

LED Status	Description	
Power LED	Off	No connection
	On	Connection

Installation

The lens must be purchased separately. If you'd like to purchase a lens, contact your camera retailer. This camera supports manual iris lenses and DC type auto iris lenses, it can be mounted with CS-mount or C-mount type when connect to the camera.



- Product color and design may vary depending on the model.
- We recommend megapixel lenses for clearer and higher resolution images.
- Video type auto iris lenses are not supported.
- Use a lens that weighs less than 450g. Heavier lenses can cause the camera to lose its balance.



- Check the wall or ceiling to see if it needs to be reinforced. The camera may fall off if the wall or ceiling is not strong enough to support its weight.
- Install the camera in a shaded area. If the camera is installed in direct sunlight, it may be affected adversely.

CS-Mount Lens

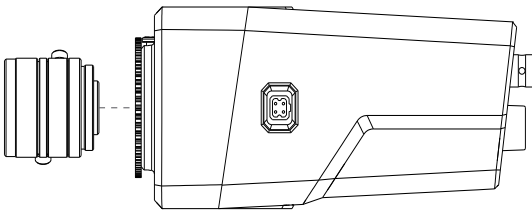

- 1 Remove the protective cover from the camera.
- 2 Turn the lens in clockwise direction and mount it on the camera.

C-Mount Lens

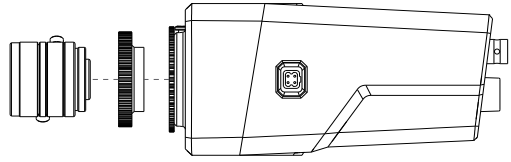

- 1 Remove the protective cover from the camera.
- 2 Turn the mount ring in clockwise direction and mount the ring on to the camera.
- 3 Turn the C-mount lens in clockwise direction and mount it on to the C-mount ring.

Mounting

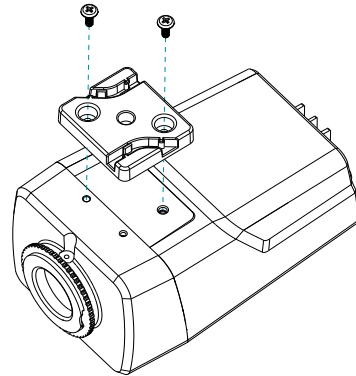

Install the bracket on the top or the bottom of the camera to secure it. For bracket installation, use 1/4-20 UNC (20 Thread), 2.5mm +/- 0.2mm (ISO standard), or 0.197 (ASA Standard) standard screws.

Dimensions

Front

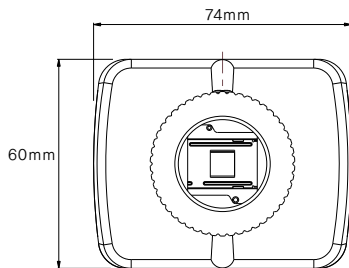

Side

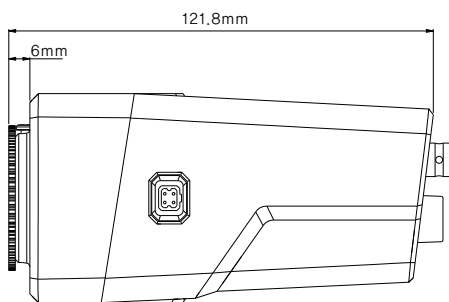

Part 2 - Camera Connection

DirectCX DVR Layout

TC-B5501X

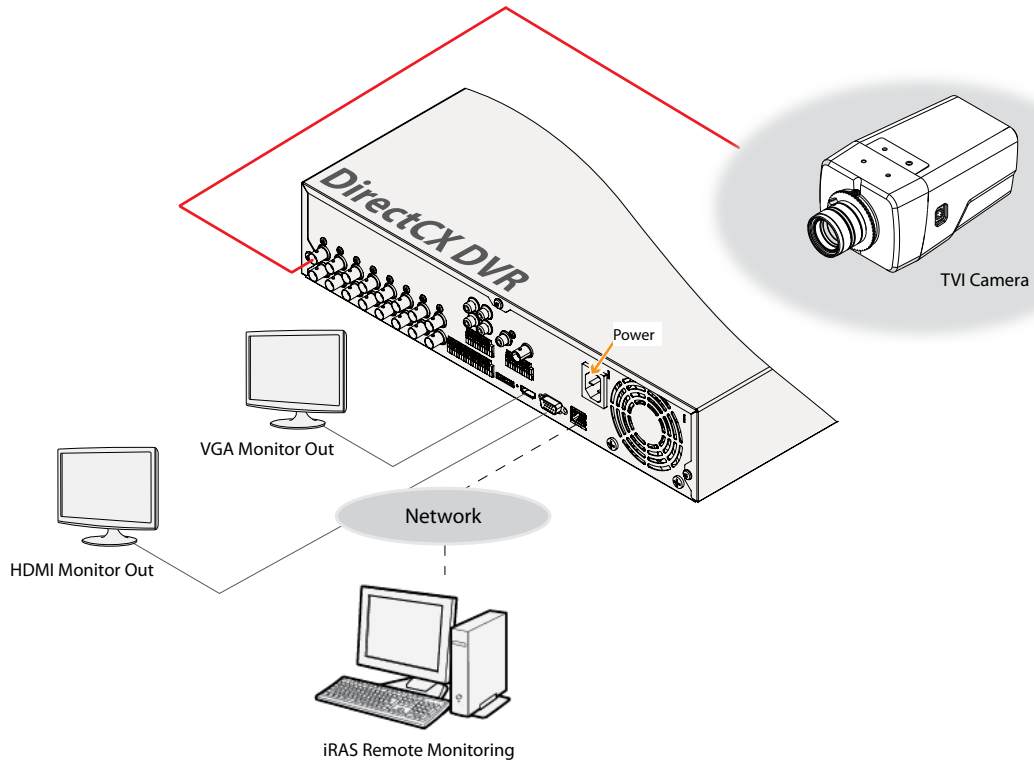

TC-B5501XP

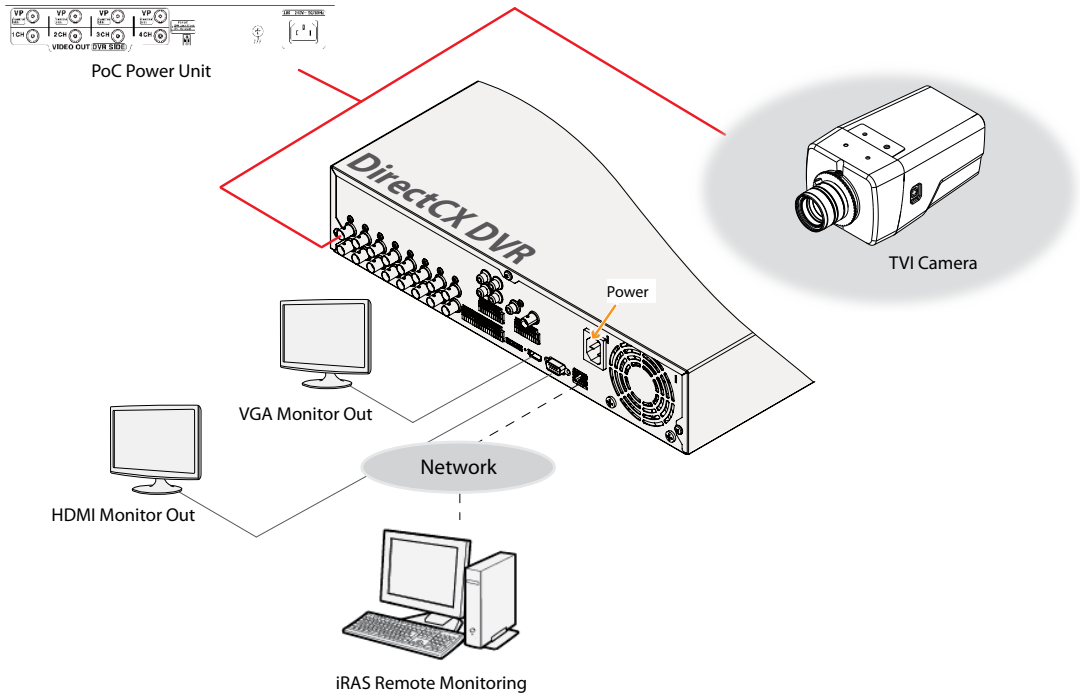

Part 3 - Appendix

Troubleshooting

Problem	Check
The main unit won't turn on.	<ul style="list-style-type: none">• Check the power cable connection. If using the PoC power, check the connection of the coaxial cable.• Check the power outlet. If using the PoC power, check the device power.
I can't see Live videos.	<ul style="list-style-type: none">• Check the camera's power status.• Check the connection status of the DVR device.• If using the PoC power, check the connection status of the PoC device.• Check the removal of the camera lens cover.• For a manual iris lens, make sure the iris is open. For a DC type auto iris lens, check the connection of the auto iris jack.
Images are blurry.	<ul style="list-style-type: none">• Make sure the lens is clean. If not, clean it using a soft piece of cloth or a brush.• Make sure the lens is in focus. Adjust the focus during daytime.• If there is too much light coming into the camera or the camera is picking up an overly bright light source, adjust the camera's position/angle accordingly.
Video color appears incorrect.	Check the white balance settings. If using the Auto option, it may take some time for the white balance to be adjusted.
Images are blinking.	<ul style="list-style-type: none">• If the camera is pointed at the sun or a fluorescent lamp, adjust the camera's angle away.• For a DC type auto iris lens, check the connection of the auto iris jack.

Specifications



These product specifications may change without prior notice.

Camera

Image Sensor	1/2.8" CMOS
Max. Resolution	2592x1944
Scanning Mode	Progressive Scan
Lens type	Optional (CS/C-Mount)
Iris Control	Manual iris, DC type auto iris (megapixel recommended)
Min. Illumination	COLOR : 0.12Lux @ F 1.3 B&W : 0.06Lux @F 1.3
Dynamic Range	True WDR
Electronic Shutter Speed	Auto, Manual (1/30 ~ 1/30,000), Anti-Flicker, Sense-up(OFF, X2, X4, X8, X16, X32)
White Balance	Auto, Auto Expansion, AWC-SET, Manual
Day & Night	Auto, Manual
Video Out *	1 BNC
Auto Iris Out	4-pin mini din jack (standard connection)

Video

Video Output	TVI / AHD / SD
Max. Frame Rate	20fps : 2592 x 1944 12.5fps : 2592 x 1944 30fps : 2560 x 1440 30fps : 1920 x 1080 30fps : 720 x 480
Supported Resolution	2592 x 1944, 2560 x 1440, 1920 x 1080, 720 x 480

General

Operating Temperature	-10°C ~ +50°C (-50°F ~ +122°F)	
Operating Humidity	0% ~ 90%	
Power Source	TC-B5501X	DC 12V
	TC-B5501XP	PoC
Power Consumption	TC-B5501X	Maximum 1.8W
	TC-B5501XP	Maximum 3.2W
Approval	FCC, CE <i>No FCC CE certification for TC-B5501XP</i>	
External Dimensions (W x H x D)	74mm x 60mm x 121.9mm (2.91" x 2.36" x 4.79")	
Weight (Main Unit)	0.24kg (0.52lb)	



IDIS Co., Ltd.

For more information, please visit at
www.idisglobal.com