



Digital Video Recorder

Installation Manual



TR-1204C

Before reading this manual

This manual contains basic instructions on installing and using Digital Video Recorder, an IDIS product. Users who are using this product for the first time, as well as users with experience using comparable products, must read this manual carefully before use and heed to the warnings and precautions contained herein while using the product. Safety warnings and precautions contained in this manual are intended to promote proper use of the product and thereby prevent accidents and property damage and must be followed at all times. Once you have read this manual, keep it at an easily accessible location for future reference.

- 
 • The manufacturer will not be held responsible for any product damage resulting from the use of unauthorized parts and accessories or from the user's failure to comply with the instructions contained in this manual.
- It is recommended that first-time users of Digital Video Recorder and individuals who are not familiar with its use seek technical assistance from their retailer regarding product installation and use.
- If you need to disassemble the product for functionality expansion or repair purposes, you must contact your retailer and seek professional assistance.
- Both retailers and users should be aware that this product has been certified as being electromagnetically compatible for commercial use. If you have sold or purchased this product unintentionally, please replace with a consumer version.

Safety Precautions



	CAUTION	
RISK OF ELECTRIC SHOCK DO NOT OPEN		
CAUTION: TO REDUCE THE RISK OF ELECTRIC SHOCK, DO NOT REMOVE COVER (OR BACK). NO USER-SERVICEABLE PARTS INSIDE. REFER SERVICING TO QUALIFIED SERVICE PERSONNEL.		



The lightning flash with arrowhead symbol, within an equilateral triangle, is intended to alert the user to the presence of uninsulated "dangerous voltage" within the product's enclosure that may be of sufficient magnitude to constitute a risk of electric shock.



The exclamation point within an equilateral triangle is intended to alert the user to the presence of important operating and maintenance (servicing) instructions in the literature accompanying the appliance.

Symbol	Publication	Description
	IEC60417, No.5032	Alternating current
	IEC60417, No.5031	Direct current

Important Safeguards

1. Read Instructions

All the safety and operating instructions should be read before the appliance is operated.

2. Retain Instructions

The safety and operating instructions should be retained for future reference.

3. Cleaning

Unplug this equipment from the wall outlet before cleaning it. Do not use liquid aerosol cleaners. Use a damp soft cloth for cleaning.

4. Attachments

Never add any attachments and/or equipment without the approval of the manufacturer as such additions may result in the risk of fire, electric shock or other personal injury.

5. Water and/or Moisture

Do not use this equipment near water or in contact with water.

6. Ventilation

Place this equipment only in an upright position. This equipment has an open-frame Switching Mode Power Supply (SMPS), which can cause a fire or electric shock if anything is inserted through the ventilation holes on the side of the equipment.

7. Accessories

Do not place this equipment on an unstable cart, stand or table. The equipment may fall, causing serious injury to a child or adult, and serious damage to the equipment. Wall or shelf mounting should follow the manufacturer's instructions, and should use a mounting kit approved by the manufacturer.



This equipment and cart combination should be moved with care. Quick stops, excessive force, and uneven surfaces may cause the equipment and cart combination to overturn.

8. Power Sources

This equipment should be operated only from the type of power source indicated on the marking label. If you are not sure of the type of power, please consult your equipment dealer or local power company.

You may want to install a UPS (Uninterruptible Power Supply) system for safe operation in order to prevent damage caused by an unexpected power stoppage. Any questions concerning UPS, consult your UPS retailer.

This equipment should be remain readily operable.

9. Power Cords

Operator or installer must remove power and TNT connections before handling the equipment.

10. Lightning

For added protection for this equipment during a lightning storm, or when it is left unattended and unused for long periods of time, unplug it from the wall outlet and disconnect the antenna or cable system. This will prevent damage to the equipment due to lightning and power-line surges.

11. Overloading

Do not overload wall outlets and extension cords as this can result in the risk of fire or electric shock.

12. Objects and Liquids

Never push objects of any kind through openings of this equipment as they may touch dangerous voltage points or short out parts that could result in a fire or electric shock. Never spill liquid of any kind on the equipment.

13. Servicing

Do not attempt to service this equipment yourself. Refer all servicing to qualified service personnel.

14. Damage requiring Service

Unplug this equipment from the wall outlet and refer servicing to qualified service personnel under the following conditions:

- A. When the power-supply cord or the plug has been damaged.
- B. If liquid is spilled, or objects have fallen into the equipment.
- C. If the equipment has been exposed to rain or water.
- D. If the equipment does not operate normally by following the operating instructions, adjust only those controls that are covered by the operating instructions as an improper adjustment of other controls may result in damage and will often require extensive work by a qualified technician to restore the equipment to its normal operation.
- E. If the equipment has been dropped, or the cabinet damaged.
- F. When the equipment exhibits a distinct change in performance - this indicates a need for service.

15. Replacement Parts

When replacement parts are required, be sure the service technician has used replacement parts specified by the manufacturer or that have the same characteristics as the original part. Unauthorized substitutions may result in fire, electric shock or other hazards.

16. Safety Check

Upon completion of any service or repairs to this equipment, ask the service technician to perform safety checks to determine that the equipment is in proper operating condition.

17. Field Installation

This installation should be made by a qualified service person and should conform to all local codes.

18. Correct Batteries

Warning: Risk of explosion if battery is replaced by an incorrect type. Replace only with the same or equivalent type. Dispose of used batteries according to the instructions. The battery shall not be exposed to excessive heat such as sunshine, fire or the like.

19. Tmra

A manufacturer's maximum recommended ambient temperature (Tmra) for the equipment must be specified so that the customer and installer may determine a suitable maximum operating environment for the equipment.

20. Elevated Operating Ambient Temperature

If installed in a closed or multi-unit rack assembly, the operating ambient temperature of the rack environment may be greater than room ambient. Therefore, consideration should be given to installing the equipment in an environment compatible with the manufacturer's maximum rated ambient temperature (Tmra).

21. Reduced Air Flow

Installation of the equipment in the rack should be such that the amount of airflow required for safe operation of the equipment is not compromised.

22. Mechanical Loading

Mounting of the equipment in the rack should be such that a hazardous condition is not caused by uneven mechanical loading.

23. Circuit Overloading

Consideration should be given to connection of the equipment to supply circuit and the effect that overloading of circuits might have on over current protection and supply wiring. Appropriate consideration of equipment nameplate ratings should be used when addressing this concern.



24. Reliable Earthing (Grounding)

Reliable grounding of rack mounted equipment should be maintained. Particular attention should be given to supply connections other than direct connections to the branch circuit (e.g., use of power strips).

HDMI Port Precautions

- Use a certified cable marked with an HDMI logo when using an HDMI. The screen may not appear or a connection error may occur if you do not use a certified HDMI cable.
- It is recommended that you use the following HDMI cable type.
 - High-speed HDMI Cable
 - High-speed HDMI Cable with Ethernet

In-Text

Symbol	Type	Description
	Caution	Important information concerning a specific function.
	Note	Useful information concerning a specific function.

User's Caution Statement

Caution: Any changes or modifications to the equipment not expressly approved by the party responsible for compliance could void your authority to operate the equipment.

FCC Compliance Statement

THIS EQUIPMENT HAS BEEN TESTED AND FOUND TO COMPLY WITH THE LIMITS FOR A CLASS A DIGITAL DEVICE, PURSUANT TO PART 15 OF THE FCC RULES. THESE LIMITS ARE DESIGNED TO PROVIDE REASONABLE PROTECTION AGAINST HARMFUL INTERFERENCE WHEN THE EQUIPMENT IS OPERATED IN A COMMERCIAL ENVIRONMENT. THIS EQUIPMENT GENERATES, USES, AND CAN RADIATE RADIO FREQUENCY ENERGY AND IF NOT INSTALLED AND USED IN ACCORDANCE WITH THE INSTRUCTION MANUAL, MAY CAUSE HARMFUL INTERFERENCE TO RADIO COMMUNICATIONS. OPERATION OF THIS EQUIPMENT IN A RESIDENTIAL AREA IS LIKELY TO CAUSE HARMFUL INTERFERENCE, IN WHICH CASE USERS WILL BE REQUIRED TO CORRECT THE INTERFERENCE AT THEIR OWN EXPENSE.

WARNING: CHANGES OR MODIFICATIONS NOT EXPRESSLY APPROVED BY THE PARTY RESPONSIBLE FOR COMPLIANCE COULD VOID THE USER'S AUTHORITY TO OPERATE THE EQUIPMENT.

THIS CLASS OF DIGITAL APPARATUS MEETS ALL REQUIREMENTS OF THE CANADIAN INTERFERENCE CAUSING EQUIPMENT REGULATIONS.

WEEE (Waste Electrical & Electronic Equipment)

Correct Disposal of This Product

(Applicable in the European Union and other European countries with separate collection systems)



This marking shown on the product or its literature, indicates that it should not be disposed with other household wastes at the end of its working life. To prevent possible harm to the environment or human health from uncontrolled waste disposal, please separate this from other types of wastes and recycle it responsibly to promote the sustainable reuse of material resources.

Household users should contact either the retailer where they purchased this product, or their local government office, for details of where and how they can take this item for environmentally safe recycling.

Business users should contact their supplier and check the terms and conditions of the purchase contract. This product should not be mixed with other commercial wastes for disposal.

Copyright

© 2020 IDIS Co., Ltd.

IDIS Co., Ltd. reserves all rights concerning this manual.

Use or duplication of this manual in part or whole without the prior consent of IDIS Co., Ltd. is strictly prohibited.

Contents of this manual are subject to change without prior notice.

Registered Trademarks

IDIS is a registered trademark of IDIS Co., Ltd.

Other company and product names are registered trademarks of their respective owners.

The information in this manual is believed to be accurate as of the date of publication even though explanations of some functions may not be included. We are not responsible for any problems resulting from the use thereof. The information contained herein is subject to change without notice. Revisions or new editions to this publication may be issued to incorporate such changes.

The software included in this product contains some Open Sources. You may obtain the complete corresponding source code depending on whether or not the source is publicly available under a license policy. Go to System Setup - About page for more information. This product includes software developed by the University of California, Berkeley and its contributors, and software developed by the OpenSSL Project for use in the OpenSSL Toolkit (<http://www.openssl.org/>). Also, this product includes cryptographic software written by Eric Young (eay@cryptsoft.com), and software written by Tim Hudson (tjh@cryptsoft.com).

Table of Contents

1

Part 1 – Introduction..... 7

- Product Features7
- Accessories.....8
- Overview9
 - Front Panel.....9
 - Dimensions.....10
 - Rear Panel11
 - Rear Panel Connections12

2

Part 2 - Appendix..... 15

- System Log Types15
- Error Code Types16
- Troubleshooting19
- Specifications20

Part 1 – Introduction

Product Features

This is a video recorder that supports surveillance, recording, and playback of video from analog cameras (or video encoders).

This DVR (Digital Video Recorder) unit offers the following features:

- Real-time 4 channel network surveillance
- Supports up to Full HD 120ips video recording
- HDMI out (1) and VGA out (1) ports
- Fast and easy search feature (Time-Lapse, Event log, Motion)
- Simultaneously survey, record, play back, and transmit data in real-time
- Graphic User Interface(GUI) and multilingual
- Multiple recording modes (Schedule, Event, Pre-Event, and Panic)
- 2 x USB 2.0 (for connecting peripherals, upgrading software, and saving recording data)
- 1 internal SATA2 HDD bay
- Self-diagnosis and automated system event alerts (industry standard S.M.A.R.T. protocol for HDD status alerts)

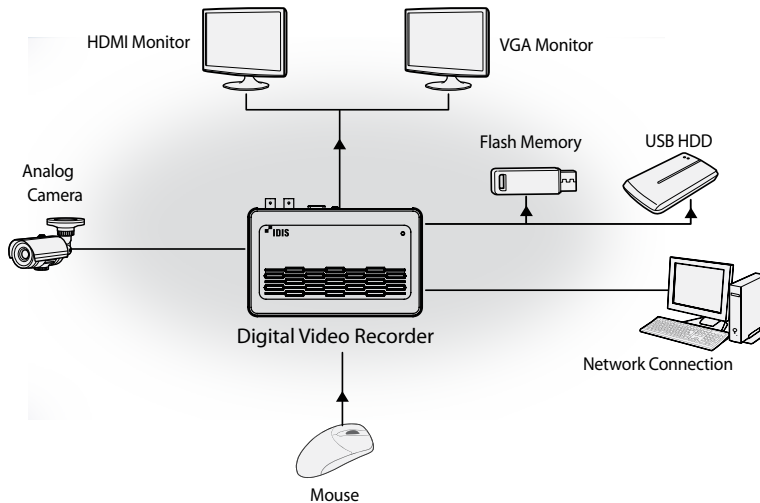

Accessories

Upon unpackaging the product, check the contents inside to ensure that all the following accessories are included.

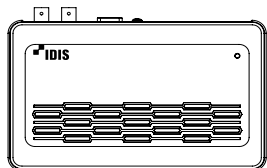

Digital Video Recorder

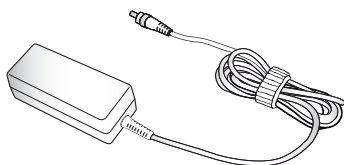

Adapter

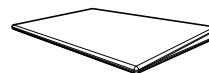

Quick Guide



Optical USB Mouse

Overview

Front Panel and Dimensions

(Unit: mm)

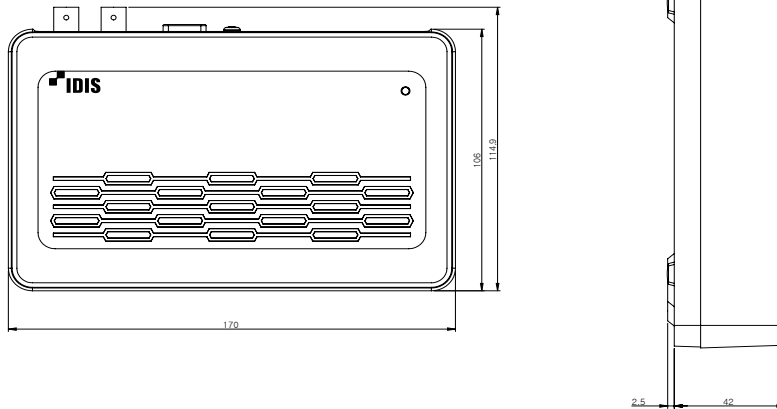

- Access various windows and menus using a USB mouse as you would on a personal computer.
- The IDIS logo should be positioned correctly when fixing the product to the wall.

Rear Panel

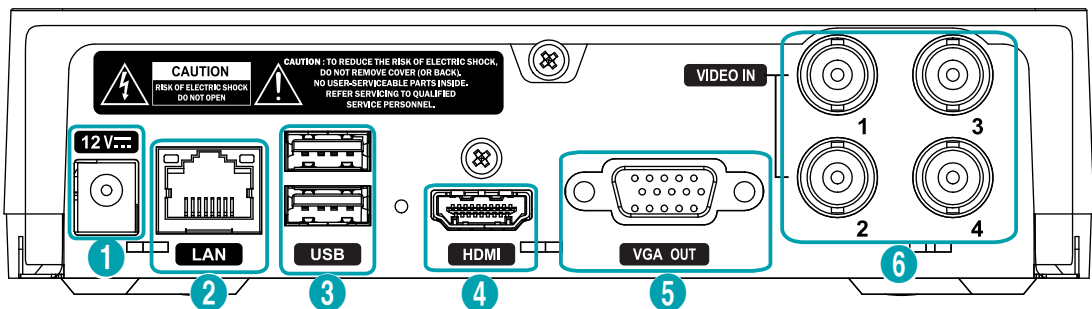

1	Power In Port (12V)	2	Network Port	3	USB Port
4	HDMI Out Port	5	VGA Out Port	6	Video In Port

Rear Panel Connections

Monitor Connection

Connect to the **HDMI** or **VGA OUT** port.

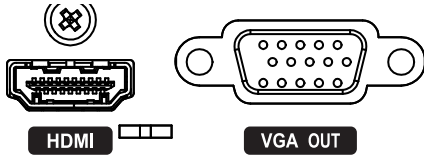

Network Connection

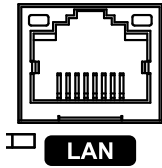

This DVR is capable of connecting to networks via an ethernet connector. Connect an RJ-45 cable (Cat5, Cat5e, or Cat6) to the DVR's network port. It's possible to operate and upgrade the DVR remotely over a network. For more information on ethernet connection setup, refer to **Network Setup in the operation manual**.

- ✓ Green LED on the right will begin to turn on if connected a 100Mbps network. The LED will turn off if connected a 10Mbps network. Orange LED on the left will flash once when a link has been established.

Video Connection

• Video In Port

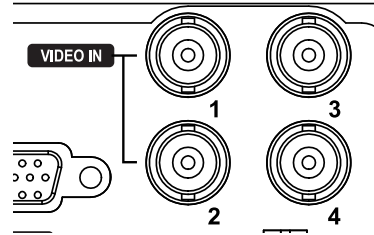

Connect the coaxial cables from the video sources to the composite Video In connectors or BNC connectors.

Power Cable Connection

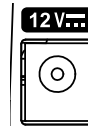

This DVR does not feature a separate power on/off button and will turn on the moment power is supplied. Connect the connector(12V) of adapter to the DVR and then connect the AC power cable of adapter to the power outlet.

- ✓ Organize the power cable so that it will not cause people to trip over or become damaged from chairs, cabinets, desks, and other objects in the vicinity. Do not run the power cable underneath a rug or carpet.
- Do not connect multiple devices to a single power outlet.

Connections on the Rear Panel

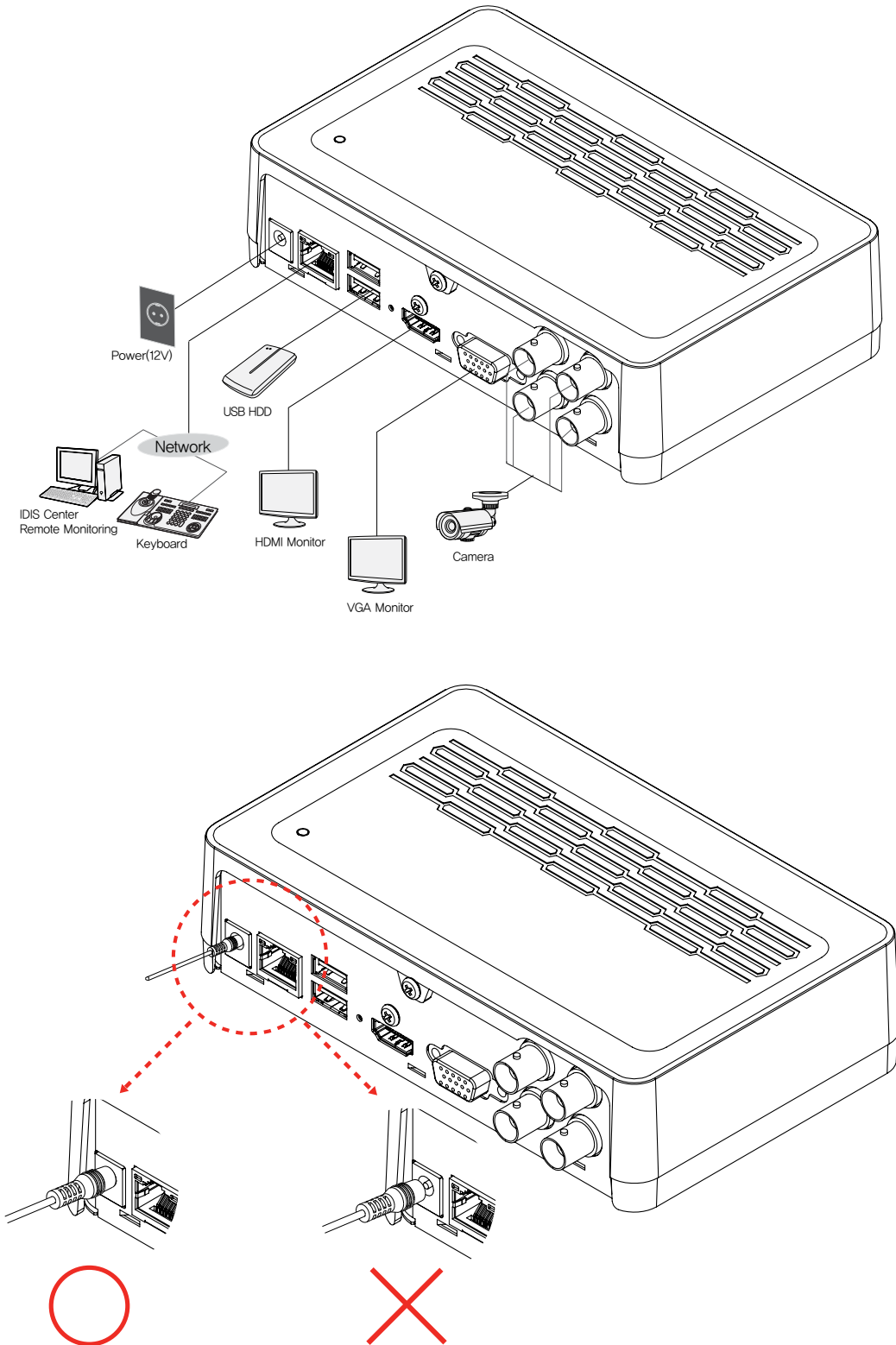

Part 2 - Appendix

System Log Types





Boot Up	Panic On
System Shutdown	Panic Off
Restart	Clear All Data
Upgrade Success	Clear Disk
Upgrade Error	Format Disk
Power Failure	Disk Full
Time Changed	Disk Config Change
Time Zone Change	Disk 'No.' : 'serial number'
Time Sync.	Disk 'No.' : Removed
Time Sync. Failed	Auto Deletion
Disk Bad	Search Begin
Login	Search End
Logout	Clip-Copy Begin
Setup Begin	Clip-Copy End
Setup End	Clip-Copy Cancel
Remote Setup Change	Clip-Copy Failure
Remote Setup Failure	Clip Copy User
Setup Import	Clip-Copy Begin
Setup Import Failure	Clip-Copy Finished
Setup Export	Clip Copy Duration of Video
Setup Export Failure	Clip Copy Camera
Setup Export Canceled	Callback Failed
Schedule On	Factory Reset
Schedule Off	

Error Code Types

Upgrade Error Codes			
No.	Type	No.	Type
0	Unknown Error	301	Remote Network Error
1	Incorrect File Version	302	No Remote Upgrade Permission
2	Incorrect OS Version	303	Remote Upgrade File Save Failure
3	Incorrect Software Version	304	Remote Upgrade Cancelled by User
4	Incorrect Kernel Version	400	USB Storage Device Mount Failure
100	Storage Device Mount Failure	401	USB Storage Device File Read Failure
101	File Not Found	402	USB Storage Device File Copy Failure
102	File Decompression Failure	403	USB Device Not Connected
103	LILO Execution Failure	404	USB Storage Device in Use
104	Reboot Failure	405	Unsupported File System
105	Improper File	500	Clip Copy in Progress: Upgrade Not Available
300	Remote Connection Failure		

Clip Copy Error Codes			
No.	Type	No.	Type
0	Unknown Error	12	Disk Error
1	Device Error	13	Clip Player Execution File Not Found
2	Device Connection Failure	14	Clip Player Execution File Access Failure
4	Incorrect Media	15	Clip Player Execution File Save Failure
5	File Name Taken	16	Image Generation Failure
6	Insufficient Space	19	Device Connection Failure
7	Temporary File Generation Failure	20	Device in Use
8	Disk Access Failure	21	Unsupported File System
9	Disk Format Failure	22	Data Validation Failure
10	Database Changed	23	Data Not Found
11	Save Failure		

Troubleshooting

Problem	Solution
The main unit won't turn on.	<ul style="list-style-type: none"> • Check the power cable connection status. • Check the power outlet.
Unable to display Live video.	<ul style="list-style-type: none"> • Check the camera's video cable connection status. • Check the monitor's video cable connection status. • Check the camera's power setting. • Check the camera lens settings.
DVR stopped working in the middle of a recording.	<ul style="list-style-type: none"> • Hard disk may be full. Delete video recordings to free up space. • Set the DVR to Recycle mode. For more information, refer to the <u>General in the operation manual</u>.
 icon is shown, but video is not being recorded.	If the Pre-Event is enabled, the  and  icons appears when recording is not in progress, or the  and  icons appear when an event occurs and recording is in progress. For more information, refer to the <u>Schedule in the operation manual</u> .

Specifications

These product specifications may change without prior notice.

General	
Exterior Dimensions (W x H x D)	6.7" x 1.8" x 4.5"(170mm x 44.5mm x 114.9mm)
Weight (Main Unit)	0.44kg (with 1TB HDD)
Working Temperature	0°C – 40°C
Operating Humidity	0% – 90%
Power Input	US: ADAPTER (INPUT: 100~240V AC, 50/60Hz, 1.0A / OUTPUT: 12V DC, 3A) ETC: ADAPTER (INPUT: 100~240V AC, 50/60Hz, 1.2A / OUTPUT: 12V DC, 3A)
Power Consumption	12V  , 0.54A, 6.48W
Certifications	FCC, CE
Video	
Video In	Composite or HD-TVI : 4 inputs, 1 Vp-p, auto-terminating, 75 Ohms
Monitor Out	1 HDMI, 1 VGA
Video Resolution	HDMI: 1920x1080, 1440x900, 1280x1024 VGA: 1920x1080, 1440x900, 1280x1024
Recording Speed (IPS)	Real-time: 120 ips @ Full HD
Playback Speed (IPS)	Full Duplex: 120 ips @ D1
I/O	
Network Connection	10Mbps/100Mbps Ethernet

Connectors	
Video In	Composite or HD-TVI : 4 inputs, 1 Vp-p, auto-terminating, 75 Ohms
Monitor Out	1 HDMI, 1 VGA
Ethernet Port	1 RJ-45
USB Ports	2 x USB 2.0

Storage	
Primary Storage	SATA hard disk drive
Clip Copy Device	USB Storage Device (USB HDD, USB Memory, etc.)

Some hard disks may not function properly when mounted on to this product. Refer to the compatibility chart below before mounting any additional hard disk on to the product. Hard disk compatibility chart is subject to change without notice. Contact your retailer for the latest compatibility chart.

Storage	Manufacturer	Model	Note
1.0TB	Seagate	ST1000VT001	
	Toshiba	DT01ABA100V	
2.0TB	Western Digital	WD20PURZ-85GU6Y0	
4.0TB	Western Digital	WD4NPURX-64NZ6Y0	



IDIS Co., Ltd.

For more information, please visit at
www.idisglobal.com