



Hybrid Network Video Recorder

Installation Manual



TR-2604

Before reading this manual

This manual contains basic instructions on installing and using Hybrid Network Video Recorder, an IDIS product. Users who are using this product for the first time, as well as users with experience using comparable products, must read this manual carefully before use and heed to the warnings and precautions contained herein while using the product. Safety warnings and precautions contained in this manual are intended to promote proper use of the product and thereby prevent accidents and property damage and must be followed at all times. Once you have read this manual, keep it at an easily accessible location for future reference.

- ✓ • The manufacturer will not be held responsible for any product damage resulting from the use of unauthorized parts and accessories or from the user's failure to comply with the instructions contained in this manual.
- It is recommended that first-time users of Hybrid Network Video Recorder and individuals who are not familiar with its use seek technical assistance from their retailer regarding product installation and use.
- If you need to disassemble the product for functionality expansion or repair purposes, you must contact your retailer and seek professional assistance.
- Both retailers and users should be aware that this product has been certified as being electromagnetically compatible for commercial use. If you have sold or purchased this product unintentionally, please replace with a consumer version.

Safety Precautions



	CAUTION	
RISK OF ELECTRIC SHOCK DO NOT OPEN		
CAUTION: TO REDUCE THE RISK OF ELECTRIC SHOCK, DO NOT REMOVE COVER (OR BACK). NO USER-SERVICEABLE PARTS INSIDE. REFER SERVICING TO QUALIFIED SERVICE PERSONNEL.		



The lightning flash with arrowhead symbol, within an equilateral triangle, is intended to alert the user to the presence of uninsulated "dangerous voltage" within the product's enclosure that may be of sufficient magnitude to constitute a risk of electric shock.



The exclamation point within an equilateral triangle is intended to alert the user to the presence of important operating and maintenance (servicing) instructions in the literature accompanying the appliance.

Symbol	Publication	Description
	IEC60417, No.5032	Alternating current
	IEC60417, No.5031	Direct current

Important Safeguards

1. Read Instructions

All the safety and operating instructions should be read before the appliance is operated.

2. Retain Instructions

The safety and operating instructions should be retained for future reference.

3. Cleaning

Unplug this equipment from the wall outlet before cleaning it. Do not use liquid aerosol cleaners. Use a damp soft cloth for cleaning.

4. Attachments

Never add any attachments and/or equipment without the approval of the manufacturer as such additions may result in the risk of fire, electric shock or other personal injury.

5. Water and/or Moisture

Do not use this equipment near water or in contact with water.

6. Ventilation

Place this equipment only in an upright position. This equipment has an open-frame Switching Mode Power Supply (SMPS), which can cause a fire or electric shock if anything is inserted through the ventilation holes on the side of the equipment.

7. Accessories

Do not place this equipment on an unstable cart, stand or table. The equipment may fall, causing serious injury to a child or adult, and serious damage to the equipment. Wall or shelf mounting should follow the manufacturer's instructions, and should use a mounting kit approved by the manufacturer.



This equipment and cart combination should be moved with care. Quick stops, excessive force, and uneven surfaces may cause the equipment and cart combination to overturn.

8. Power Sources

This equipment should be operated only from the type of power source indicated on the marking label. If you are not sure of the type of power, please consult your equipment dealer or local power company.

You may want to install a UPS (Uninterruptible Power Supply) system for safe operation in order to prevent damage caused by an unexpected power stoppage. Any questions concerning UPS, consult your UPS retailer.

9. Power Cords

Operator or installer must remove power and TNT connections before handling the equipment.

10. Lightning

For added protection for this equipment during a lightning storm, or when it is left unattended and unused for long periods of time, unplug it from the wall outlet and disconnect the antenna or cable system. This will prevent damage to the equipment due to lightning and power-line surges.

11. Overloading

Do not overload wall outlets and extension cords as this can result in the risk of fire or electric shock.

12. Objects and Liquids

Never push objects of any kind through openings of this equipment as they may touch dangerous voltage points or short out parts that could result in a fire or electric shock. Never spill liquid of any kind on the equipment.

13. Servicing

Do not attempt to service this equipment yourself. Refer all servicing to qualified service personnel.

14. Damage requiring Service

Unplug this equipment from the wall outlet and refer servicing to qualified service personnel under the following conditions:

- A. When the power-supply cord or the plug has been damaged.
- B. If liquid is spilled, or objects have fallen into the equipment.
- C. If the equipment has been exposed to rain or water.
- D. If the equipment does not operate normally by following the operating instructions, adjust only those controls that are covered by the operating instructions as an improper adjustment of other controls may result in damage and will often require extensive work by a qualified technician to restore the equipment to its normal operation.
- E. If the equipment has been dropped, or the cabinet damaged.
- F. When the equipment exhibits a distinct change in performance this indicates a need for service.

15. Replacement Parts

When replacement parts are required, be sure the service technician has used replacement parts specified by the manufacturer or that have the same characteristics as the original part. Unauthorized substitutions may result in fire, electric shock or other hazards.

16. Safety Check

Upon completion of any service or repairs to this equipment, ask the service technician to perform safety checks to determine that the equipment is in proper operating condition.

17. Field Installation

This installation should be made by a qualified service person and should conform to all local codes.

18. Correct Batteries

Warning: Risk of explosion if battery is replaced by an incorrect type. Dispose of used batteries according to the instructions.

19. Tmra

A manufacturer's maximum recommended ambient temperature (Tmra) for the equipment must be specified so that the customer and installer may determine a suitable maximum operating environment for the equipment.

20. Elevated Operating Ambient Temperature

If installed in a closed or multi-unit rack assembly, the operating ambient temperature of the rack environment may be greater than room ambient. Therefore, consideration should be given to installing the equipment in an environment compatible with the manufacturer's maximum rated ambient temperature (Tmra).

21. Reduced Air Flow

Installation of the equipment in the rack should be such that the amount of airflow required for safe operation of the equipment is not compromised.

22. Mechanical Loading

Mounting of the equipment in the rack should be such that a hazardous condition is not caused by uneven mechanical loading.



23. Circuit Overloading

Consideration should be given to connection of the equipment to supply circuit and the effect that overloading of circuits might have on over current protection and supply wiring. Appropriate consideration of equipment nameplate ratings should be used when addressing this concern.

24. Reliable Earthing (Grounding)

Reliable grounding of rack mounted equipment should be maintained. Particular attention should be given to supply connections other than direct connections to the branch circuit (e.g., use of power strips).

In-Text

Symbol	Type	Description
	Caution	Important information concerning a specific function.
	Note	Useful information concerning a specific function.

User's Caution Statement

Caution: Any changes or modifications to the equipment not expressly approved by the party responsible for compliance could void your authority to operate the equipment.

FCC Compliance Statement

THIS EQUIPMENT HAS BEEN TESTED AND FOUND TO COMPLY WITH THE LIMITS FOR A CLASS A DIGITAL DEVICE, PURSUANT TO PART 15 OF THE FCC RULES. THESE LIMITS ARE DESIGNED TO PROVIDE REASONABLE PROTECTION AGAINST HARMFUL INTERFERENCE WHEN THE EQUIPMENT IS OPERATED IN A COMMERCIAL ENVIRONMENT. THIS EQUIPMENT GENERATES, USES, AND CAN RADIATE RADIO FREQUENCY ENERGY AND IF NOT INSTALLED AND USED IN ACCORDANCE WITH THE INSTRUCTION MANUAL, MAY CAUSE HARMFUL INTERFERENCE TO RADIO COMMUNICATIONS. OPERATION OF THIS EQUIPMENT IN A RESIDENTIAL AREA IS LIKELY TO CAUSE HARMFUL INTERFERENCE, IN WHICH CASE USERS WILL BE REQUIRED TO CORRECT THE INTERFERENCE AT THEIR OWN EXPENSE.

WARNING: CHANGES OR MODIFICATIONS NOT EXPRESSLY APPROVED BY THE PARTY RESPONSIBLE FOR COMPLIANCE COULD VOID THE USER'S AUTHORITY TO OPERATE THE EQUIPMENT.

THIS CLASS OF DIGITAL APPARATUS MEETS ALL REQUIREMENTS OF THE CANADIAN INTERFERENCE CAUSING EQUIPMENT REGULATIONS.

WEEE (Waste Electrical & Electronic Equipment)

Correct Disposal of This Product

(Applicable in the European Union and other European countries with separate collection systems)



This marking shown on the product or its literature, indicates that it should not be disposed with other household wastes at the end of its working life. To prevent possible harm to the environment or human health from uncontrolled waste disposal, please separate this from other types of wastes and recycle it responsibly to promote the sustainable reuse of material resources.

Household users should contact either the retailer where they purchased this product, or their local government office, for details of where and how they can take this item for environmentally safe recycling.

Business users should contact their supplier and check the terms and conditions of the purchase contract. This product should not be mixed with other commercial wastes for disposal.

Copyright

© 2025 IDIS Co., Ltd.

IDIS Co., Ltd. reserves all rights concerning this manual.

Use or duplication of this manual in part or whole without the prior consent of IDIS Co., Ltd. is strictly prohibited.

Contents of this manual are subject to change without prior notice.

Registered Trademarks

IDIS is a registered trademark of IDIS Co., Ltd.

Other company and product names are registered trademarks of their respective owners.

The information in this manual is believed to be accurate as of the date of publication even though explanations of some functions may not be included. We are not responsible for any problems resulting from the use thereof. The information contained herein is subject to change without notice. Revisions or new editions to this publication may be issued to incorporate such changes.

The software included in this product contains some Open Sources. You may obtain the corresponding source code which we have to distribute according to the license policy. Go to System Setup - About page for more information. This product includes software developed by the University of California, Berkeley and its contributors, and software developed by the OpenSSL Project for use in the OpenSSL Toolkit (<http://www.openssl.org/>). Also, this product includes cryptographic software written by Eric Young (eay@cryptsoft.com), and software written by Tim Hudson (tjh@cryptsoft.com).

Table of Contents

1

Part 1 – Introduction.....	7
Product Features	7
Accessories.....	9
Overview	10
Front Panel.....	10
Rear Panel	11
Rear Panel Connections	12

2

Part 2 - Appendix.....	16
System Log Types	16
Error Code Types	17
Troubleshooting	19
Specifications	20

Part 1 – Introduction

Product Features

This is a Hybrid video recorder that supports surveillance, recording, and playback of video from analog cameras and network cameras (or video encoders).

This NVR (Network Video Recorder) unit offers the following features:

- Real-time channels surveillance
- Compatible with Color (NTSC or PAL) and B&W (CCIR and EIA-170) Video Sources
- H.264(not supported for the analog cameras), H.265 Codec
- Real-time 120ips analog camera video recording (standard for Full HD resolution)
- Real-time 60ips network camera video recording (standard for UHD resolution)
- Auto Detection for HD-TVI, AHD, NTSC and PAL/Auto Detection for FHD, 3MP, 4MP and 5MP / Camera Auto Detection for HD and SD
- HDMI out (1) and VGA out (1) ports at the same time
- UTC for camera menu control (controls camera menu using coax cable)
- Fast and easy search feature (Time-Lapse, Event log, Motion, Text-In)
- Simultaneously survey, record, play back, and transmit data in real-time
- Graphic User Interface(GUI) and multilingual
- Multiple recording modes (Schedule, Event, Pre-Event, and Panic)
- Continuous Recording in Disk Overwrite Mode
- Two USB 2.0 ports (for connecting peripherals, upgrading software, and saving recording data)
- Text Input for ATM and POS
- Two-way audio communication
- 4-channel audio recording and 1-channel audio playback
- Network camera audio recording and 1-channel audio playback
- 4 alarm ins, 1 alarm out, and Built-in Alarm Buzzer
- Automated system event alerts (industry standard S.M.A.R.T. protocol for HDD status alerts)
- Real-time 2 channels DirectIP network surveillance
- Network camera zero configuration
- Configuration-free network camera access
- Exports setup, system log and clip-copy files on network

Part 1 – Introduction

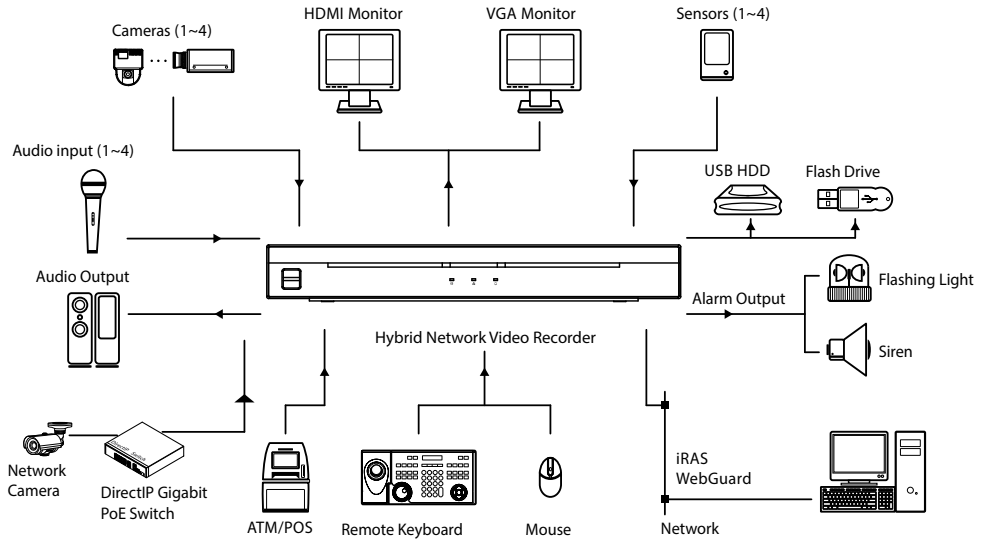

Accessories

Upon unpackaging the product, check the contents inside to ensure that all the following accessories are included.

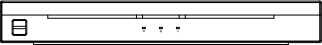
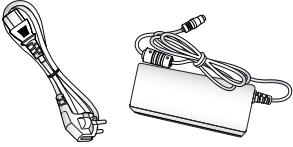
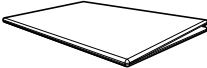
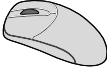
		
Hybrid Network Video Recorder	Power Adapter/Power Cable	Quick Guide
		
Optical USB Mouse		

Overview

Front Panel

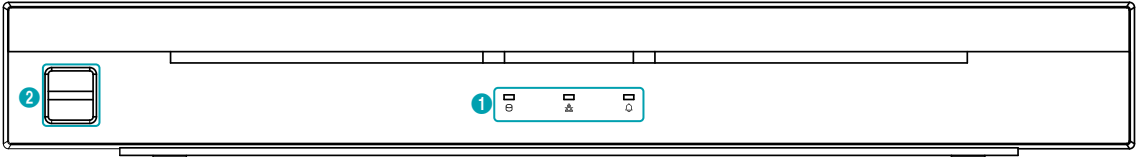

① HDD/Network/Alarm LEDs	② USB Ports
--------------------------	-------------

- Access various windows and menus using a USB mouse as you would on a personal computer.
- For easier system configuration, a USB mouse is recommended.

① LEDs

- **HDD LED:** Lights up when data is being written on the HDD or a video search is in progress.
- **Network LED:** Lights up when the device is connected to network through ethernet.
- **Alarm LED:** Lights up in red when an alarm event occurs.

② USB Ports

• Storage Device Connection

Connect an external USB hard drive or a USB flash memory device to one of the USB ports for use with the Clip Copy feature. The external storage device should be placed as close to the NVR as possible. It is recommended that you use a connection cable that is no longer than 180cm in length. Use the connection cable included with your external storage device to connect the device to one of NVR's USB ports. For more information Clip Copy, refer to the **Clip Copy in the operation manual.**

• Peripheral Device Connection

Use the USB ports to connect peripherals such as a USB mouse to the NVR. You can also use a USB-to-serial converter and connect multiple text-in devices to the NVR at the same time.

- For USB flash memory devices, the NVR supports the FAT32 file format only.

Connections on the Front Panel

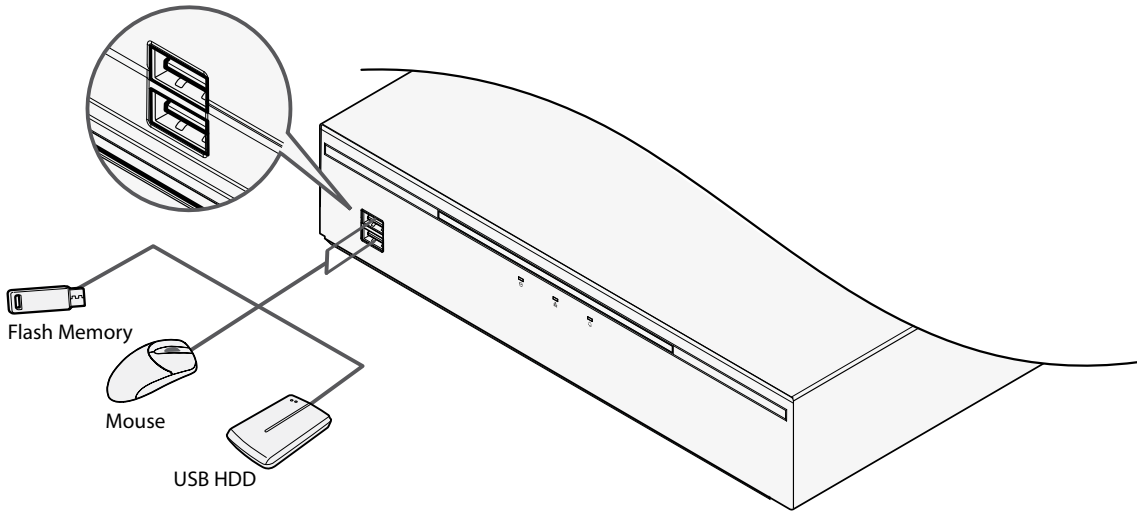

Rear Panel

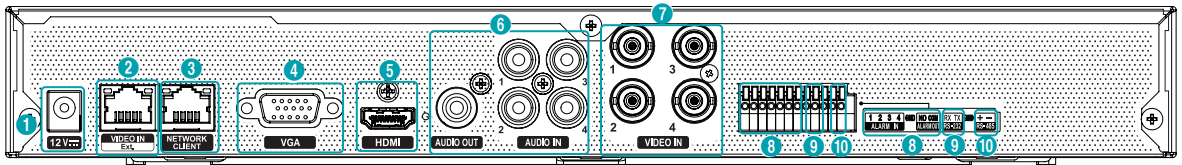

1	Power In Port	2	RJ-45 Video Input Port	3	Network ClientPort	4	VGA Out Port
5	HDMI Out Port	6	Audio Connection Ports	7	Video Input Port	8	Alarm Connection Ports
9	RS-232 Port	10	RS-485 Port				

Rear Panel Connections

Power Cable Connection

Connect the power cable to this port. This NVR does not feature a separate power on/off button and will turn on the moment power is supplied.

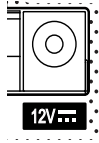

- ✓ Organize the power cable so that it will not cause people to trip over or become damaged from chairs, cabinets, desks, and other objects in the vicinity. Do not run the power cable underneath a rug or carpet.
- The power cable is grounded. Do not modify the power plug even if your power outlet does not have a ground contact.
- Do not connect multiple devices to a single power outlet.

Video Connection

RJ45 Video In Port

Connect network cameras or video encoders to the NVR using RJ-45 cable (Cat5, Cat5e, or Cat6). In addition to cameras or video encoders, you can connect external hubs (Optional: DH-2112PF, DH-2128PF, DH-2212PF) to form a network. The NVR recognizes DirectIP network cameras automatically.

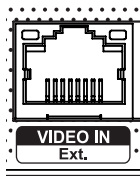

- ✓ Green LED on the right will turn on if connected to a 100 BASE-T network. Orange LED on the left will then flash once a link has been established

Network Client Connection

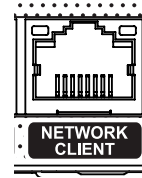

This NVR is capable of connecting to networks via the 10Mb/100Mb ethernet connector. Connect an RJ-45 cable (Cat5/Cat5e/Cat6) to the NVR's network port. It's possible to operate and upgrade the NVR remotely over a network. For more information on ethernet connection setup, refer to **Network Setup in the operation manual**.

- ✓ Connector directions may vary depending on the NVR model.

Monitor Connection

Connect to the **VGA OUT** or **HDMI** port.

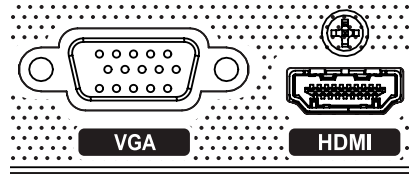

Audio Connection

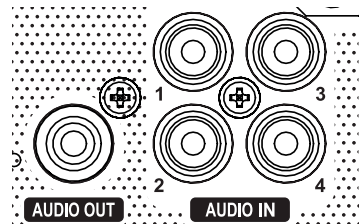

Connect the audio device to the **AUDIO IN** port and speakers with a built-in amplifier to the **AUDIO OUT** port. Use the **AUDIO OUT** port to listen to audio from analog cameras and network cameras.

Use the **AUDIO IN** port to establish two-way communication with cameras.

-  This NVR does not feature a built-in audio amplifier unit and therefore requires the user to purchase a speaker system with a built-in amplifier separately. It's possible to connect an amplified audio source to the NVR, but microphones that do not have a built-in amplifier will not function properly if connected to the NVR directly. If this is the case, connect the microphone to the NVR via a pre-amp.
- Check your local laws and regulations on making audio recordings.

Alarm Connection

Connect alarm connectors to these ports.

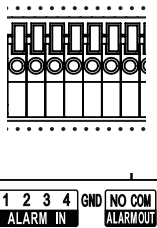

-  Press down on the button and insert the cable into the opening. Release the button and then pull on the cable slightly to ensure it is held securely in place. To disconnect the cable, press down on the button again and pull the cable out.

- #### Alarm In 1 through 4

This NVR is capable of responding to event signals from external alarm in devices. Connect mechanical or electrical switches to AI 1 through 4 and the GND (ground) connector. In order to be recognized by the NVR, the signal from an alarm in device must be less than 0.3V (Normally Open) and maintained for at least 0.5 seconds. The alarm in voltage range is 0V to 5V. For more information on alarm in setup, refer to the **Alarm-In in the operation manual.**

- #### GND (Ground)

Connect alarm in or out's ground cable to the GND connector.

-  All connectors marked "GND" are common connectors.

- #### NO/COM (Relay Alarm Outputs)

This NVR is capable of activating/deactivating buzzers, lights, and other external devices. Connect the device to the COM and NO (Normally Open) connectors. NO is a relay output which sinks 2A@125VAC and 1A@30VDC. For more information on alarm out setup, refer to the **Alarm-Out in the operation manual.**

- #### Connector Arrangement

AI1 through AI 4	Alarm In 1 through 4
GND	Ground
COM	Relay Common
NO	Normally Open Relay Alarm Out

RS-232 Connection

Connect an external device such as a POS unit to this port.

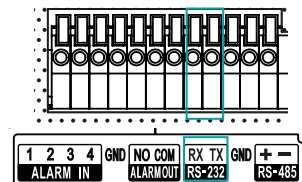

- #### Connector Pin Outs

Master Unit	Slave Unit
	RX → To → TXD
	TX → To → RXD
	GND → To → GND

Part 1 – Introduction

Refer to the following for pin-out details for the 9-pin connector of the slave unit.

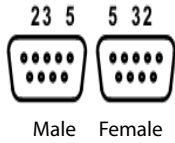

Pin 2	RXD (Receive Data)
Pin 3	TXD (Transmit Data)
Pin 5	GND (Ground)

RS-485 Connection

This NVR supports the RS-485 half-duplex serial communication protocol for connecting to external devices such as POS units. The RS-485 connector can also be used to control PTZ (pan, tilt, zoom) cameras. Connect RX+/TX+ and RX-/TX- of the control system to the + and - (respectively) of the NVR.

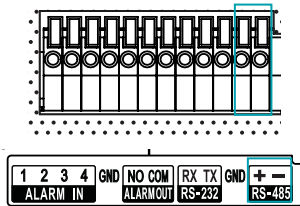

• **Connector Pin Outs**

Master Unit	Slave Unit
+ → To	→ TX+/RX+
- → To	→ TX-/RX-

Video Connection

Analog Video Input

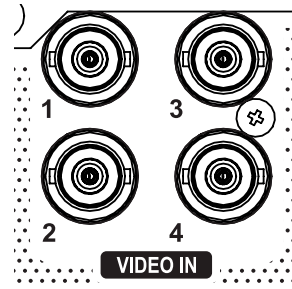

Connect the coaxial cables from the video sources to the composite Video In connectors.

Quality cannot be guaranteed when connecting using a method other than coaxial cable.

Connections on the Rear Panel

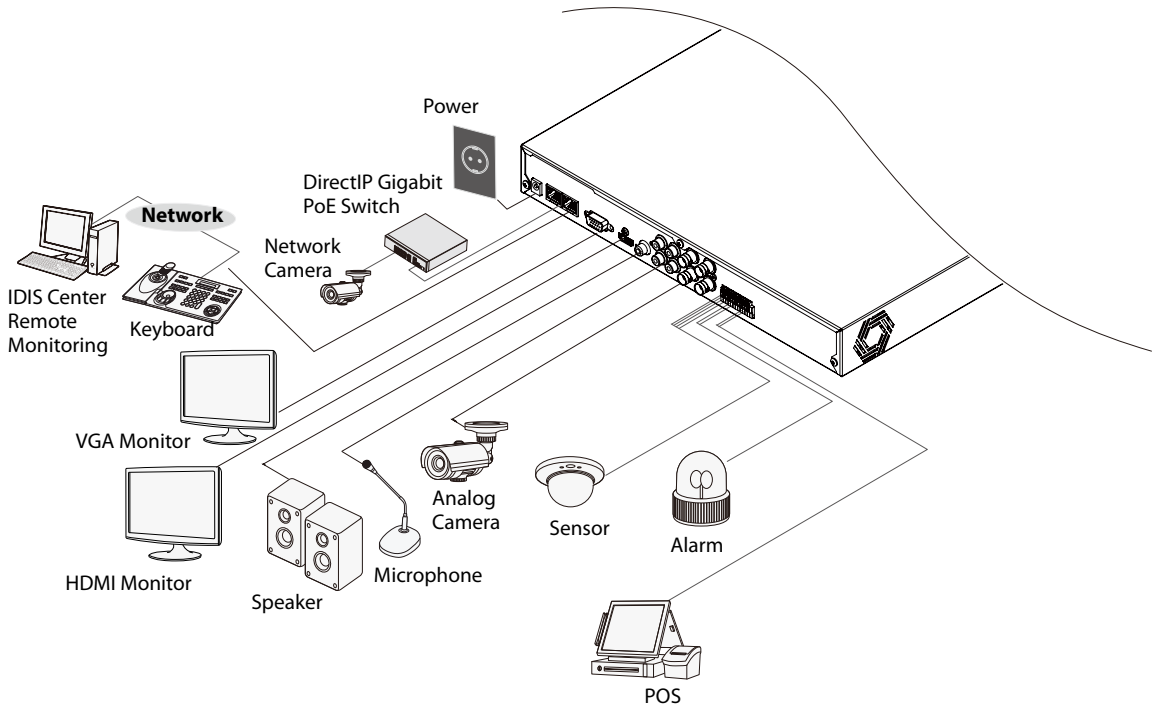

Part 2 - Appendix

System Log Types

Boot Up	Panic Off
System Shutdown	Clear All Data
Restart	Clear Disk
Upgrade Success	Format Disk
Upgrade Error	Disk Full
Power Failure	Auto Deletion
Time Changed	Search Begin
Time Zone Change	Search End
Time Sync.	Clip-Copy Begin
Time Sync. Failed	Clip-Copy End
Disk Bad	Clip-Copy Cancel
Login	Clip-Copy Failure
Logout	Clip Copy User
Setup Begin	Clip-Copy Begin
Setup End	Clip-Copy Finished
Remote Setup Change	Clip Copy Duration of Video
Remote Setup Failure	Clip Copy Camera
Setup Import	Callback Failed
Setup Import Failure	Factory Reset
Setup Export	Camera Upgrade Begin
Setup Export Failure	Camera Upgrade End
Setup Export Canceled	Camera Upgrade Failed
Schedule On	Camera Upgrade User
Schedule Off	Camera Upgrade Camera
Panic On	





Error Code Types

Upgrade Error Codes			
No.	Type	No.	Type
0	Unknown Error	301	Remote Network Error
1	Incorrect File Version	302	No Remote Upgrade Permission
2	Incorrect OS Version	303	Remote Upgrade File Save Failure
3	Incorrect Software Version	304	Remote Upgrade Cancelled by User
4	Incorrect Kernel Version	400	USB Storage Device Mount Failure
100	Storage Device Mount Failure	401	USB Storage Device File Read Failure
101	File Not Found	402	USB Storage Device File Copy Failure
102	File Decompression Failure	403	USB Device Not Connected
103	LILO Execution Failure	404	USB Storage Device in Use
104	Reboot Failure	405	Unsupported File System
105	Improper File	500	Clip Copy in Progress: Upgrade Not Available
300	Remote Connection Failure		

Clip Copy Error Codes			
No.	Type	No.	Type
0	Unknown Error	11	Save Failure
1	Device Error	12	Disk Error
2	Device Connection Failure	13	Clip Player Execution File Not Found
4	Incorrect Media	14	Clip Player Execution File Access Failure
5	File Name Taken	15	Clip Player Execution File Save Failure
6	Insufficient Space	16	Image Generation Failure
7	Temporary File Generation Failure	19	Device Connection Failure
8	Disk Access Failure	20	Device in Use
9	Disk Format Failure	21	Unsupported File System
10	Database Changed	22	Data Validation Failure
		23	No Saved Data within Range

Network Error Codes			
No.	Type	No.	Type
0	Cause of Failure Unknown	20	Connection Cancelled by User
1	Normal Logout	21	No Response from Network Device Host
2	All Channels in Use - Connection Denied	22	High Network Noise Level
3	Incorrect Product Version Info	23	Transmission Queue Full
4	Incorrect User Name or Password	24	Incorrect OEM Info
5	Forced Disconnection by Admin	25	No Search Permission
6	Timeout	26	Port in Use
7	Network Device Terminated	27	SSL Connection Failure
8	Unable to Connect: No Available Port	28	Network Timeout
9	Server Not in Operation: Unable to Connect	29	Network Device Host Timeout
11	Network Unavailable	30	RTP via TCP Not Supported by Network Device Host
12	Different Network Zone: Unable to Access	31	Socket Error
13	Connection Timeout	100	Unknown CODEC
14	Forced Disconnection by Network Device	101	.jpeg CODEC (not supported)
15	Network Device Host Terminated	103	.mpeg4 CODEC (not supported)
16	Unable to Route to Network Device Host	400	Unsupported Resolution
17	Connection Severed	-1	Normal Access

Troubleshooting

Problem	Solution
The main unit won't turn on.	<ul style="list-style-type: none"> ● Check the power cable connection status. ● Check the power outlet.
Unable to display Live video.	<ul style="list-style-type: none"> ● Check the camera's video cable connection status. ● Check the monitor's video cable connection status. ● Check the camera's power setting. ● Check the camera lens settings. ● Check the current main monitor resolution.
NVR stopped working in the middle of a recording.	Set the NVR to Recycle mode. For more information, refer to the <u>General in the operation manual</u> .
 icon is shown, but video is not being recorded.	If the Pre-Event is enabled, the  and  icons appears when recording is not in progress, or the  and  icons appear when an event occurs and recording is in progress. For more information, refer to the <u>Schedule in the operation manual</u> .

Specifications

These product specifications may change without prior notice.

VIDEO	
Video Inputs	4 BNC, 1 RJ45
Video Outputs	1 HDMI, 1 VGA
Display Resolution	HDMI : 3840 x 2160, 1920 x 1080, 1280 x 1024
Display Speed	IP : 35Mbps, 60ips(2CH)@UHD Analog : 120ips@1080p,60ips@4MP, 40ips@5MP
RECORDING	
Max. Throughput	IP : 35Mbps, 60ips(2CH)@UHD Analog : 120ips@1080p, 60ips@4MPH, 40ips@5MPH
Compression	H.265 : IP-CAM / A-CAM H.264 : IP-CAM
Recording Mode	Time-Lapse, Event, Pre-Event, Panic
PLAYBACK	
Performance	4ch 1080p synchronous playback 2ch 4K + 2ch 5MP playback
Search Mode	Time-lapse, Event log, Text-in
STORAGE	
HDD	SATA x2
Total Capacity	12TB=6TB x2
Data Export Device	USB HDD, USB Stick
NETWORK	
Video in Connection	Fast Ethernet(Client) x 1
Client Connection	Fast Ethernet(Video In) x1
Transmission Speed	50Mbps
Event Notification	Email (attach clip (.cbf, .MP4)), Callback to Remote S/W, Push notification (IDIS Mobile), NetFS(FTP)
INTERFACE	
Audio In / Out	Local(NVR) : 4 / 1RCA + 1HDMI IP Camera : 2 / 2 (Depending on IP Camera)
Alarm Spec- In	4 TTL, NC/NO programmable, 3.0V (NC) or 0.3V (NO) threshold, 5VDC
Alarm Spec- Out	1 relay output, NO programmable, terminal blocks, 2A@125VAC, 1A@30VDC
Internal Buzzer	Yes
Serial Interface	RS-232 (Terminal Block), RS-485 (Terminal Block)
USB	USB 2.0 X 2

GENERAL	
Operating System	Embedded Linux
Unit Dimensions (W x H x D)	340mm x 46.5mm x 315.2mm (11.38" x 1.83" x 12.40")
Unit Weight	3.16kg (with 2 HDDs)
Working Temperature	0°C – 40°C (32°F ~ 104°F)
Operating Humidity	0% – 90%
Power Input	ADAPTER (INPUT: 100V-240V~, 50/60Hz, 1.5A / OUTPUT: 12V $\overline{\square}$, 5A)
Power Consumption	12V $\overline{\square}$, 1.83A, 21.96W
Approvals	KC, CE, FCC



Some hard disks may not function properly when mounted on to this product. Refer to the compatibility chart below before mounting any additional hard disk on to the product. Hard disk compatibility chart is subject to change without notice. Contact your retailer for the latest compatibility chart.

Storage	Manufacturer	Model	Note
2TB	Western Digital	WD22PURU-64C5JY0	
4TB	Seagate	ST4000VX015	
6TB	Western Digital	WD63PURU-64C4FY0	



IDIS Co., Ltd.

For more information, please visit at
www.idisglobal.com